

# PHOTOMULTIPLIER TUBE MODULES

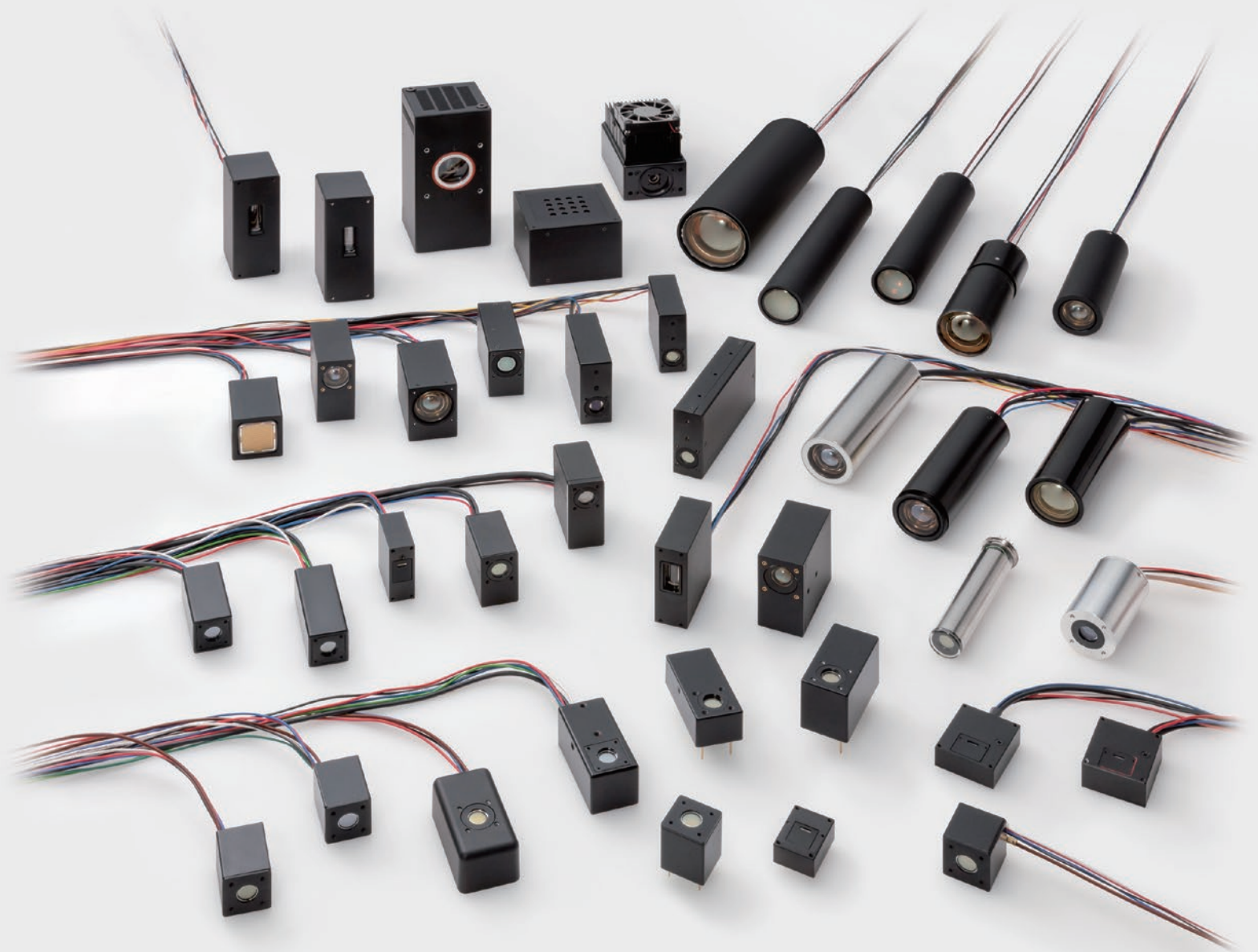

# INDEX

Usage and connections .....	P.02
Application examples .....	P.03
Product specifications .....	P.06
Analog type .....	P.06
Photon counting type .....	P.30
Related products .....	P.38
Technical guide .....	P.42
Precautions .....	P.44

## What is PMT module

The PMT module is basically comprised of a photomultiplier tube to convert light into electrical signals, a high voltage power supply circuit, and a voltage divider circuit to distribute the optimum voltage to each dynode, all assembled into a single compact case. In addition to these basic PMT modules, Hamamatsu also provides modules having various additional functions such as signal processing, cooling and interface to PC.

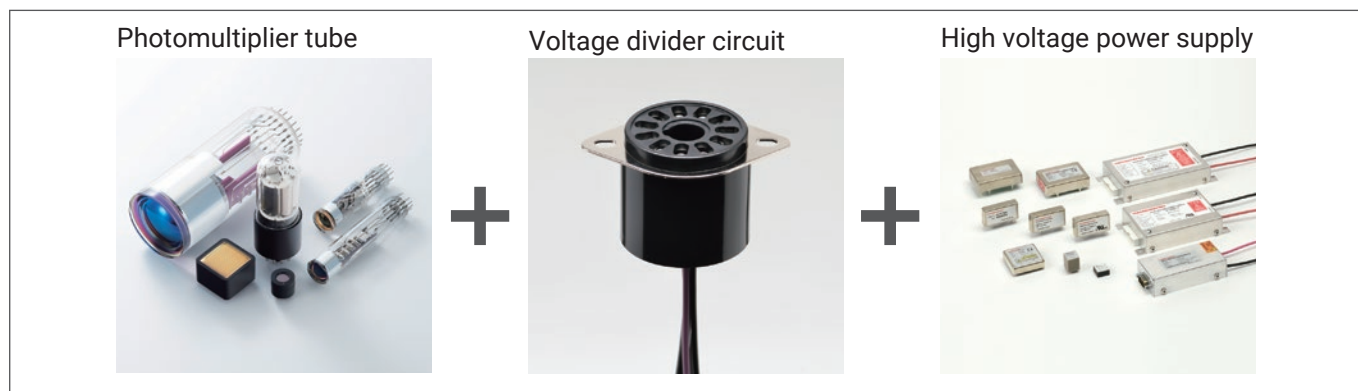





+



	<p>Amplifier (voltage output)</p>	<p>The output of photomultiplier tubes is usually a current signal, but PMT modules with an internal amplifier provide a voltage signal output for easy signal processing.</p>
	<p>Photon counting</p>	<p>PMT modules with a photon counting circuit allow photon counting measurements by simply connecting to a counter.</p>
	<p>Gate function</p>	<p>PMT modules with an electrical gate function (electronic shutter) are useful for reducing unwanted effects from excitation light or for making high-speed time-resolved measurements.</p>
	<p>Cooler</p>	<p>Cooling a photomultiplier tube is very effective in reducing noise. PMT modules with a thermoelectric cooler are especially ideal for applications such as microscopy and spectrophotometry where noise significantly affects the accuracy.</p>
	<p>CPU and interface</p>	<p>PMT modules containing a CPU and interface can be controlled from a PC, for example, to adjust the gain.</p>
	<p>Connection to optical blocks</p>	<p>Some PMT modules are designed to connect to optical blocks (sold separately) that are convenient to design optical systems.</p>

# Type No. quick reference table

## ● Analog type

PMT type	Type No.	Page	Feature	Effective area (mm)	Output type		Compatible power supply		Compatible optical options <sup>2</sup>	
					Pin	Cable <sup>1</sup>	C7169 (±15 V)	C10709 (±5 V)		
	Micro PMT	H14066	P.6	World's smallest	4 × 1	●		●	○	
		H12402	P.6		3 × 1		●	●	○	
		H12403	P.6		3 × 1		●	●	○	
		H12404	P.6	Internal amplifier	3 × 1		●	●	○	
		H12405	P.6	Internal amplifier	3 × 1		●	●	○	
	Metal package type PMT	H14600	P.8		φ8	●		●	◎	
		H14601	P.8		φ8		●	●	◎	
		H14990	P.8	Fast response	φ8		●	●	◎	
		H14950	P.8		φ8	●		●	◎	
		H14951	P.8		φ8		●	●	◎	
		H14603	P.8	Internal amplifier	φ8		●		●	◎
		H10720	P.10		φ8	●			●	◎
		H10721	P.10		φ8		●		●	◎
		H11900	P.10		φ8	●		●		◎
		H11901	P.10		φ8		●	●		◎
		H10722	P.10	Internal amplifier	φ8		●		●	◎
		H10723	P.10	Internal amplifier	φ8		●		●	◎
		H11902	P.10	Internal amplifier	φ8		●	●		◎
		H11903	P.10	Internal amplifier	φ8		●	●		◎
		H11526	P.12	Gate function	φ8 <sup>3</sup>		●	●		◎
H12056	P.12	Gate function	φ8 <sup>3</sup>	●			●	◎		
H11706	P.12	Gate function	φ8 <sup>3</sup>		●	●		◎		
H7422	P.14	Internal cooler	φ5		●	●		◎		
	Side-on type PMT	H9305	P.16		3.7 × 13.0		●	●		
		H13220	P.16		3.7 × 13.0		●		●	
		H9306	P.16	Internal amplifier	3.7 × 13.0		●	●		
		H9307	P.16	Internal amplifier	3.7 × 13.0		●	●		
		H11461	P.18		4 × 20		●		●	
		H11462	P.18	Internal amplifier	4 × 20		●		●	
		H14768	P.20	Internal cooler	10 × 14		●	●		
	Head-on type PMT	H7826	P.22		φ15	●	●		▲	
		H7827	P.22	Internal amplifier	φ15	●	●		▲	
		H13543	P.22	Square photocathode	18 × 18		●		●	
		H10425	P.24		φ22		●	●		
		H10492	P.24	Internal amplifier	φ22		●	●		
		H10426	P.24		φ25		●	●		
		H10493	P.24	Internal amplifier	φ25		●	●		
		H14447	P.26	Fast response	φ25		●		●	
		H11411	P.26		φ46		●	●		
		H11432	P.26		φ34		●		●	
		H13229	P.28	Operation in vacuum	φ8	●			●	
H14211	P.28	Operation in vacuum	φ8		●		●			

## ● Photon counting type

PMT type	Type No.	Page	Feature	Effective area (mm)	Cable end <sup>1</sup>		Compatible power supply		Compatible optical options <sup>2</sup>	
					Unterminated	Terminated with connector	C7169 (±15 V)	C10709 (±5 V)		
	Micro PMT	H12406	P.30		3 × 1	●		●	○	
		Metal package type PMT	H10682	P.30		φ8	●		●	◎
			H12386	P.30		φ8	●		●	◎
			H11890	P.30	Internal CPU and interface	φ8		●		◎
			H7421	P.14	Internal cooler	φ5		●		◎
	Side-on type PMT	H8259	P.32	Gate function	4 × 20 <sup>4</sup>	●	●	●		
		Head-on type PMT	H14870	P.33	Multi channel	φ5/ch		●	●	
			H11870	P.34		φ22 <sup>5</sup>	●		●	
			H13467	P.34		φ22	●		●	
			H11123	P.34		φ25	●		●	
			H12775	P.36		φ10	●		●	
			H7828	P.36		φ15		●	●	▲
			H9319	P.36	Internal CPU and interface	φ22		●	●	

<sup>1</sup> The cable ends of the cable output types and one end of the supplied power cables are not terminated with a connector such as a BNC connector.

These cables are available with a pre-attached connector (extra charge) if needed. Please specify the connector type along with the cable length when ordering.

<sup>2</sup> PMT modules can be used with optical accessories such as optical blocks (P.38). Marks in the table have the following meanings.

◎: Can be used with optical blocks, ○: Can be used with optical fiber adapters, ▲: Can be used with optical blocks via separate adapter.

<sup>3</sup> Type with suffix -40 has an effective area of 5 mm diameter.

<sup>4</sup> Type with suffix -02 has an effective area of 4 mm × 6 mm.

<sup>5</sup> Type with suffix -09 has an effective area of 21 mm diameter.

# Usage and connections

The cable ends of the cable output types do not have connectors such as BNC connectors. We can install a connector (extra charge) if needed. Please specify the type of connector along with the cable length when placing your order.

## Examples of connection to peripheral devices

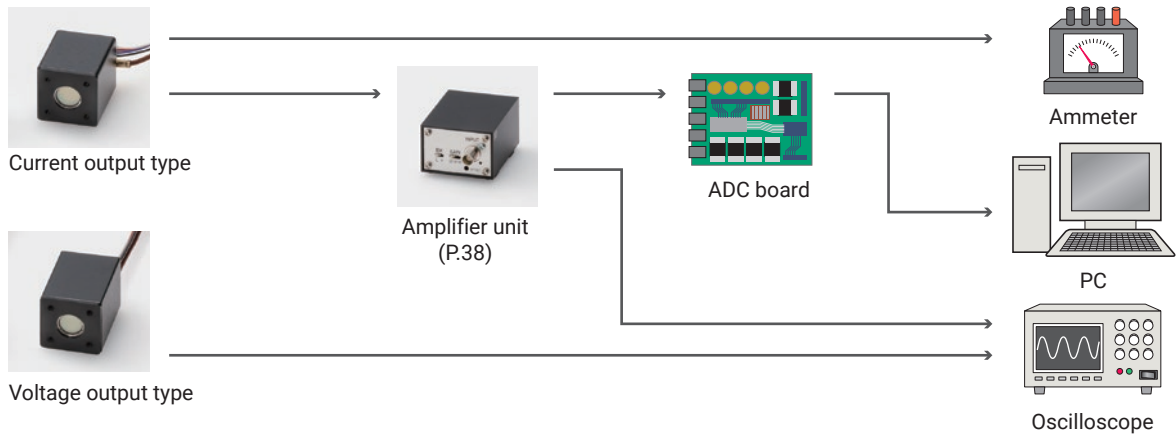

## Examples of measurement methods

### • Time-correlated single photon counting

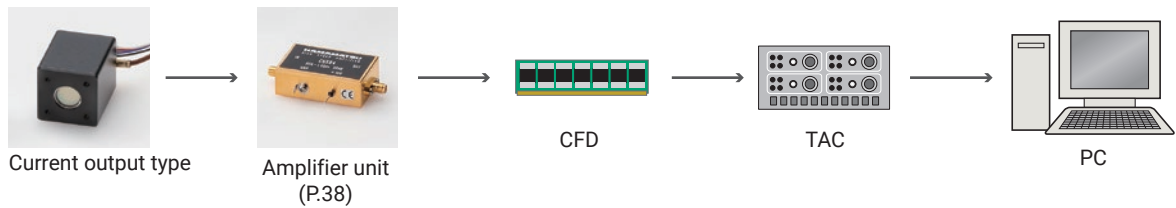

### • Photon counting

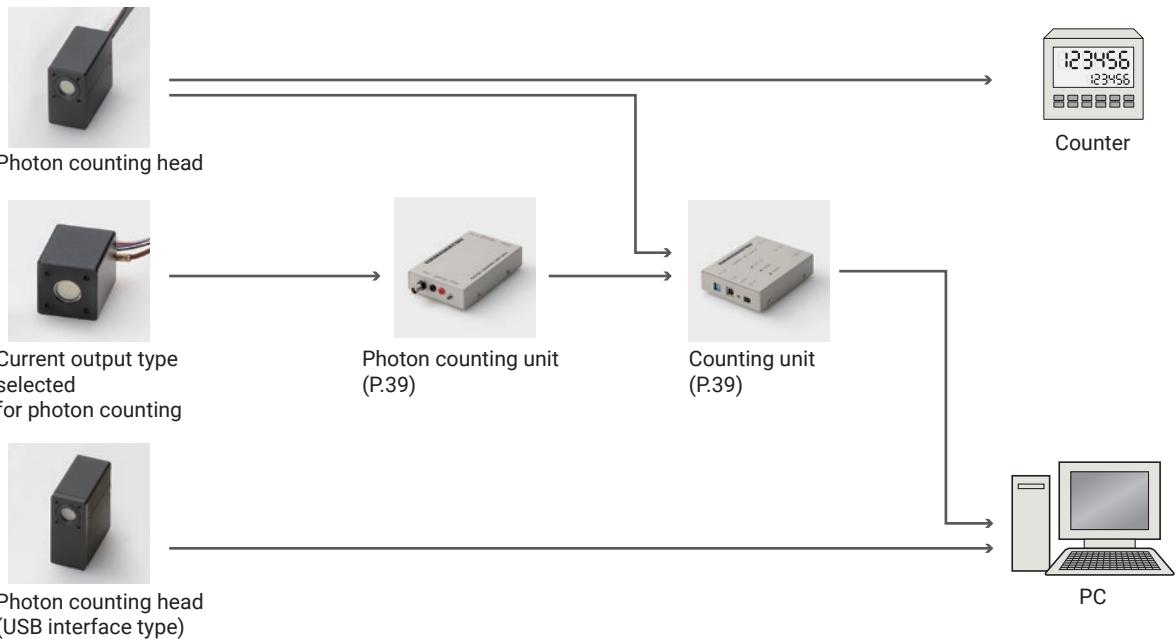



# Application examples

## Flowcytometers

In flowcytometer, cells labeled with fluorescent material flow in a solution along a flow cell while moving at a certain interval. A laser beam is then irradiated onto the cells and the scattered light from the cells and fluorescence from the fluorescent material are measured by a photomultiplier tube. Various kinds of information are acquired from the scattered light and fluorescence such as cell surface antigens, cell periods, number of cells, immunity functions and reticulocytes, and the cells can also be separated from each other. Rapid advances are recently being made in irradiation by multiple lasers, multi color analysis, high-speed operation, and compact flow systems.

### Required features

- High-speed response
- High quantum efficiency

### Recommended products

- H11900/H11901 Series
- H10720/H10721 Series
- H14600/H14601 Series
- H14950/H14951 Series

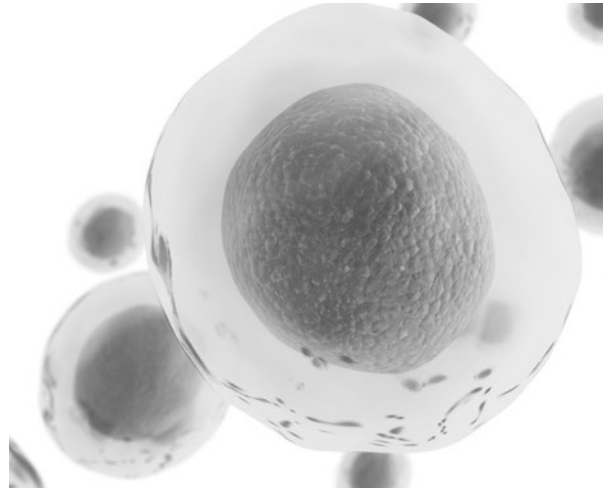

## Real-time PCR testing

PCR is an abbreviation for polymerase chain reaction and is used to detect the presence of a target analyte with high sensitivity by amplifying its DNA at high speed. PCR testing is widely used not only in research fields, but also in infectious disease testing, criminal investigations, and food inspection.

### Required features

- High sensitivity
- Internal amplifier

### Recommended products

- H10722 Series
- H11902 Series

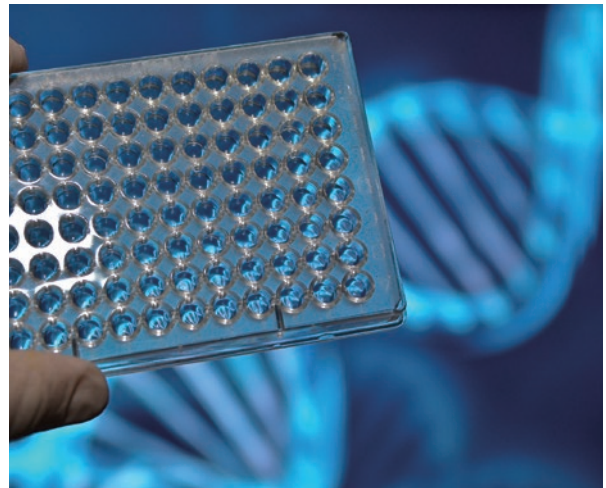

## Blood inspection

Blood contains antigens or namely substances that trigger an immune response specific to a disease or bacteria. Blood testing includes a method for finding disease or detecting bacteria and its extent or quantity by making use of a small amount of blood (plasma and serum) mixed with an antibody reagent that binds to the antigen to be assayed and then measuring the amount of luminescence that is emitted when the antibody reacts with the antigen.

While research has been conducted on increasing the binding and luminescence efficiency of reagents, there is also an ever-growing demand for making measurements and determinations with smaller sample amounts. High-sensitivity photomultiplier tubes capable of single photon counting are being applied to meet this demand.

### Required features

- Wide dynamic range
- High sensitivity

### Recommended products

- H10682-110
- H10721-110
- H7828
- H11870-01/-02
- H11123



# Application examples

## Hygiene monitor

The hygiene monitor is also called an ATP analyzer. This device extracts the ATP held in bacteria and cells and makes measurements by causing a reaction with the luminous reagent in the ATP using the firefly's light emission principle. This hygiene monitor is used for making purity checks at restaurants and factories producing foods, etc. In the test, the surface of the object for inspection is wiped with a cotton swab and the extent of dirt or contamination immediately found just by inserting the swab in the sanitary monitor. A great feature of the hygiene monitor is that the photon counting method allows highly sensitive measurements using just an extremely small amount of sample material.

### Required features

- Compact and light weight
- Low power consumption

### Recommended products

- H7828
- H10682-110



## Multi-photon microscope

In this method, fluorescent molecules can be excited with near infrared light by letting the molecules absorb two photons almost simultaneously, and the visible to UV fluorescence is observed. The cross sectional area absorbing the two photons is extremely small, so nearly all the fluorescence must be detected as a signal from the focal point. Other advantages are that nearly twice the wavelength is used compared to excitation by one photon. This not only means that unwanted effects from scattering and background noise inside the sample due to excitation light are drastically reduced but also that damage to cells from UV light is minimized.

### Required features

- High quantum efficiency

### Recommended products

- H7422-40
- H9305-03



## Time-correlated single photon counting

Time-correlated single photon counting is used to measure low-level light emitted from a sample when excited with a pulsed laser, based on the theory that a histogram obtained by repeatedly measuring the single photon many times at a slightly delayed timing represents a waveform of the emitted light. Electrical signals produced by a laser driver are slightly delayed and used as trigger signals while the PMT module detects the light emission from a sample. The PMT module output pulse signals are then input to a time-to-amplitude converter (TAC) that produces an electrical pulse in proportion to the time difference between a light detection signal and a trigger signal. A multichannel analyzer (MCA) creates a frequency distribution of the output signals from the TAC, to obtain a waveform of the light emission of the sample.

### Required features

- High-speed response
- High gain

### Recommended products

- H10721P-110
- H11901P-110
- H7422P Series



# Application examples

## Portable survey meters

Portable radiation measurement devices or survey meters are essential for detecting radioactive substances for public safety in customs inspections, nuclear power plants, and hospitals, etc. Among various radiation measurement devices, the most sensitive type uses a combination of photomultiplier tube and scintillator and offers sensitivity ranging from several ten to hundreds of times higher than Geiger-Müller counters (GM counters). Photomultiplier tubes used in this application must be compact, rugged, and easily coupled to scintillators, and also have low power consumption.

### Required features

- Compact and light weight
- Low power consumption
- Vibration-resistant

### Recommended products

- H14600-100
- H10720-110/-210
- H10721-110/-210
- H7826



## Semiconductor wafer inspection systems

These systems find defects on semiconductor wafers, by scanning a laser beam onto the wafer and then detecting the scattered light to find any debris, dirt or damage on the wafer surface. Advances in semiconductor technology have made lithographic lines on wafers even finer so that even smaller defects must now be detected making these inspection devices an essential tool.

### Required features

- High-speed response
- Wide dynamic range

### Recommended products

- H10721 Series
- H11901 Series

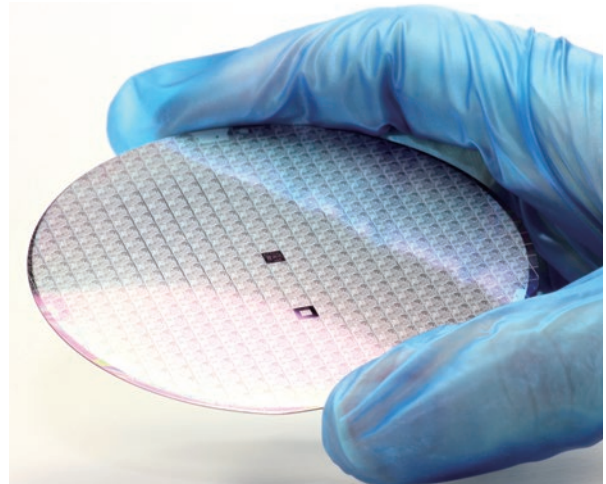

## Laser radar (LIDAR)

One use of laser radar (often called "LIDAR\*") is making atmospheric measurements. A laser beam is emitted into the atmosphere and the light scattered by the "atmospheric molecules" and "suspended elements" then detected. The scattered light is absorbed by "trace gases" during its return and is therefore extremely faint. These "trace gases, and the distribution and concentration of suspended elements" can be analyzed by measuring this faint light. Lidar is actually used in measurements of aerosol and ozone concentrations, CO<sub>2</sub>, SO<sub>2</sub> and NO<sub>x</sub> concentrations, wind velocity and also the extent of visibility.

\* LIDAR: Light Detection And Ranging

### Required features

- Gated operation
- Less after pulse

### Recommended products

- H11526 Series
- H11870-01

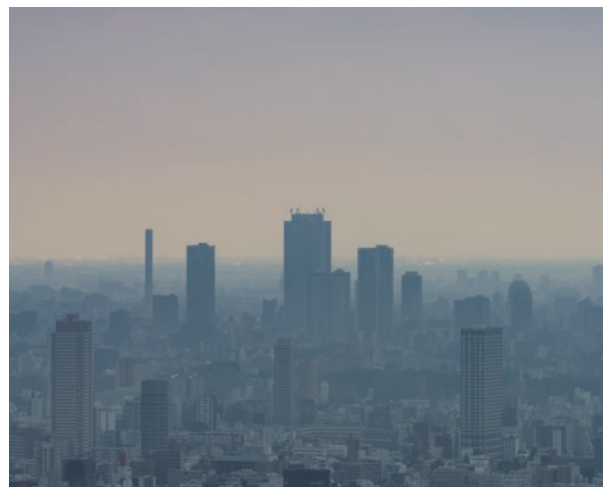

# Micro PMT modules

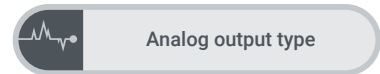

Analog output type

Micro PMT modules H12402 • H12403 • H14066 • H12404 • H12405 series

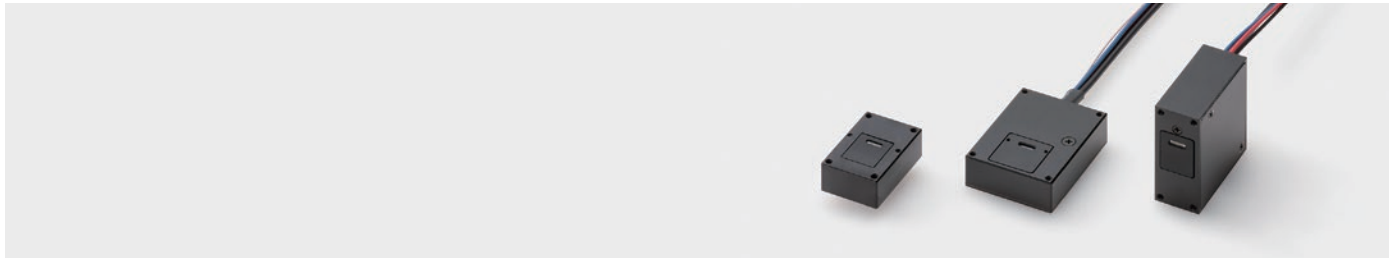

## Product line-up

(at +25 °C)

Parameter	H14066	H12402	H12403	H12404	H12405	Unit
Output	Current output			Voltage output		—
Output type	Pin	Cable				—
Effective area	1 (Y) × 4 (X)	1 (Y) × 3 (X)				mm
Input voltage	+4.75 to +5.25	+4.5 to +5.5		±4.5 to ±5.5		V
Settling time <sup>①</sup>	10					s
Operating ambient temperature	+5 to +50					°C

<sup>①</sup> The time required for the output to reach a stable level following a change in the control voltage from +1.0 V to +0.5 V

## Specifications of individual products

### • H14066

(at +25 °C)



Parameter	H14066	H14066-01	Unit
Spectral response	300 to 650	300 to 850	nm
Recommended control voltage adjustment range	+0.5 to +1.0 (Max. +1.15)	+0.5 to +1.1 (Max. +1.15)	V
Gain <sup>①</sup>	Typ. 2.0 × 10 <sup>6</sup>	3.5 × 10 <sup>5</sup>	—
Maximum average output signal current	5		μA
Dark current <sup>①</sup>	0.3		nA

<sup>①</sup> Control voltage: +0.9 V

### • H12402 / H12403

(at +25 °C)

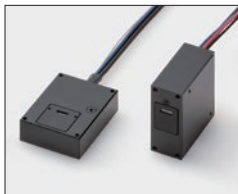

Parameter	H12402 / H12403	H12402-01 / H12403-01	H12402-20 / H12403-20	Unit
Spectral response	300 to 650	300 to 850	300 to 920	nm
Recommended control voltage adjustment range	+0.5 to +1.0 (Max. +1.15)	+0.5 to +1.1 (Max. +1.15)		V
Gain <sup>①</sup>	Typ. 2.0 × 10 <sup>6</sup>	3.5 × 10 <sup>5</sup>	2.5 × 10 <sup>5</sup>	—
Maximum average output signal current	5			μA
Dark current <sup>①</sup>	0.3		0.6	nA

<sup>①</sup> Control voltage: +0.9 V

### • H12404 / H12405

(at +25 °C)

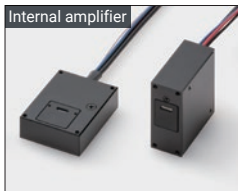

Parameter	H12404 / H12405	H12404-01 / H12405-01	H12404-20 / H12405-20	Unit
Spectral response	300 to 650	300 to 850	300 to 920	nm
Recommended control voltage adjustment range	+0.5 to +1.0 (Max. +1.15)	+0.5 to +1.1 (Max. +1.15)		V
Micro PMT gain <sup>①</sup>	Typ. 2.0 × 10 <sup>6</sup>	3.5 × 10 <sup>5</sup>	2.5 × 10 <sup>5</sup>	—
Frequency bandwidth	Max. DC to 20 kHz			kHz
Current-to voltage conversion factor	1			V/μA
Maximum output signal voltage	+4 <sup>②</sup>			V
Voltage output depending on PMT dark current <sup>①</sup>	Typ. 0.3	0.6		mV

<sup>①</sup> Control voltage: +0.9 V

<sup>②</sup> Load resistance: 10 kΩ



## Spectral response

### ● H12402 / H12403 / H12404 / H12405 / H14066 series

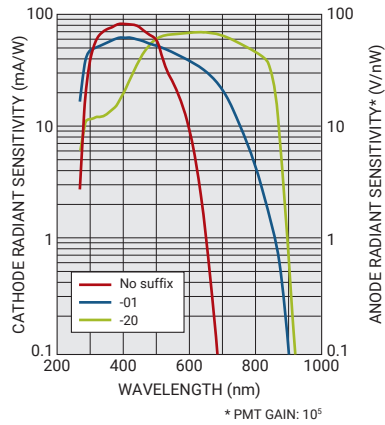

## Dimensional outline (Unit: mm)

### ● H14066 series

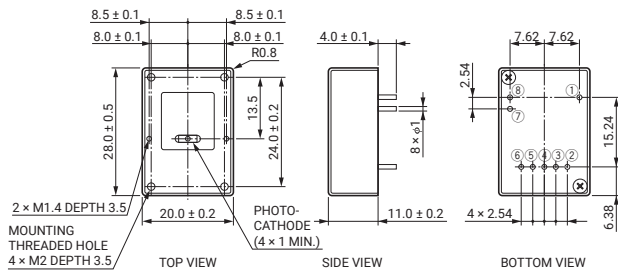

### ● H12402/H12404 series

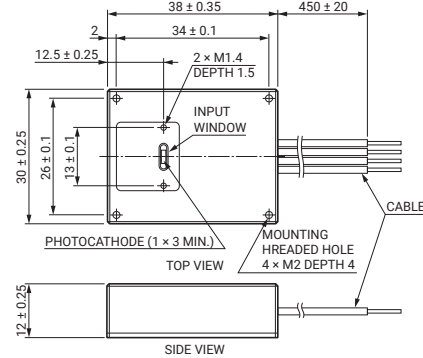

### ● H12403/H12405 series

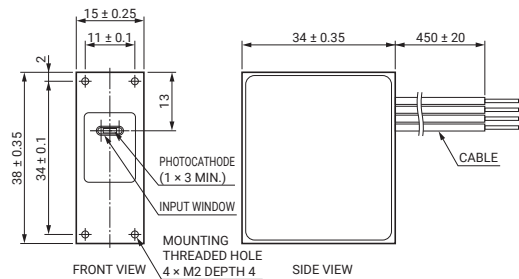

## Input section

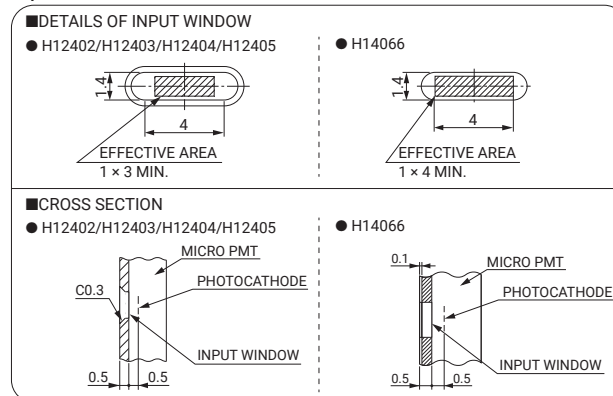

\* Optical accessories for guiding light into an optical fiber are available as options.

## ■ Signal input/output table

Signal type	H14066	H12402	H12403	H12404	H12405
	Pin position	Cable	Cable	Cable	Cable
Low voltage input (+) *1	②			Red <sup>A</sup>	
Low voltage input (-) *2		-			Green <sup>A</sup>
GND	①, ③			Black <sup>A</sup>	
Vref output *3	④			Blue <sup>A</sup>	
Vcont input *4	⑤			White <sup>A</sup>	
Signal output / Signal GND	⑦ / ⑧			Coaxial <sup>B</sup>	
NC	⑥			-	

\*1: +5 V

\*2: -5 V

\*3: +1.2 V

\*4: +0.5 V to +1.0 V (No suffix),  
+0.5 V to +1.1 V (-01/-20)

<sup>A</sup> UL1430 AWG26

<sup>B</sup> RG-174/U

# Metal package type photomultiplier tube modules

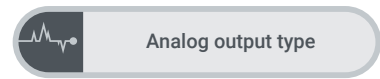

Metal package type photomultiplier tube modules H14600 • H14601 • H14603 • H14950 • H14951 series, H14990-100-02

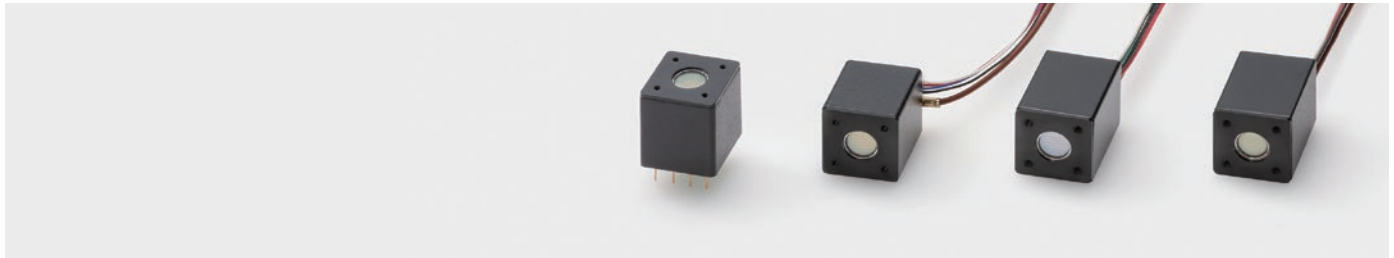

## Product line-up

(at +25 °C)

Parameter	H14600	H14601	H14990-100-02	H14950	H14951	H14603	Unit
Output	Current output					Voltage output	—
Output type	Pin	Cable		Pin	Cable	Cable	—
Effective area	$\phi 8$						mm
Input voltage	+4.5 to +5.5			+11.5 to +15.5		$\pm 4.5$ to $\pm 5.5$	V
Recommended control voltage adjustment range	+0.5 to +1.0 (Max. +1.0)						V
Settling time <sup>①</sup>	10			0.2		10	s
Operating ambient temperature	+5 to +50						°C

<sup>①</sup> The time required for the output to reach a stable level following a change in the control voltage from +0.9 V to +0.5 V

## Specifications of individual products

● H14600 / H14601 / H14950 / H14951 series

(at +25 °C)

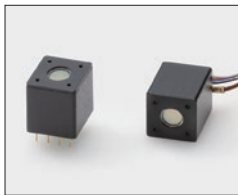

Parameter		-100	-103	-200	-01	-04	-20	Unit
Spectral response		300 to 650	185 to 650	300 to 650	300 to 870	185 to 870	300 to 920	nm
Gain <sup>①</sup>	Typ.	$1.0 \times 10^6$						—
Maximum average output signal current		100						$\mu\text{A}$
Dark current	Typ.	0.5	0.5	0.5	1	1	10	nA

<sup>①</sup> Control voltage: +0.9 V

● H14990-100-02

(at +25 °C)

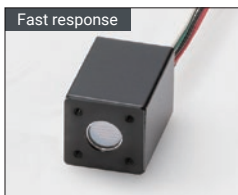

Parameter		H14990-100-02						Unit
Spectral response		300 to 650						nm
Gain <sup>①</sup>	Typ.	$2.5 \times 10^4$						—
Rise time	Typ.	0.37						ns
Maximum average output signal current		100						$\mu\text{A}$
Dark current	Typ.	0.1						nA

<sup>①</sup> Control voltage: +0.8 V

● H14603 series

(at +25 °C)

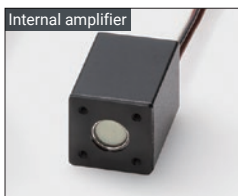

Parameter		-100	-103	-200	-01	-04	-20	Unit
Spectral response		300 to 650	185 to 650	300 to 650	300 to 870	185 to 870	300 to 920	nm
PMT gain <sup>①</sup>	Typ.	$1.0 \times 10^6$						—
Frequency bandwidth		DC to 200 kHz						—
Current-to voltage conversion factor		0.1						V/ $\mu\text{A}$
Maximum output signal voltage		$+4$ <sup>②</sup>						V
Voltage output depending on PMT dark current <sup>①</sup>	Typ.	0.5	0.5	0.5	1	1	10	mV

<sup>①</sup> Control voltage: +0.9 V

<sup>②</sup> Load resistance: 10 k $\Omega$

## Spectral response

● H14600 / H14601 / H14950 / H14951 series, H14990-100-02 / H14603 series

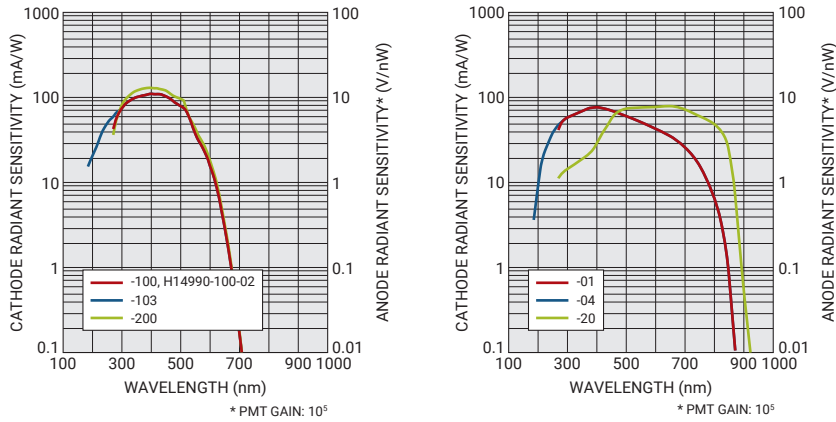

## Dimensional outline (Unit: mm)

● H14600/H14950 series

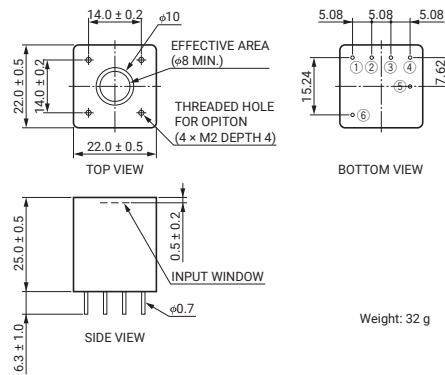

● H14601/H14951 series

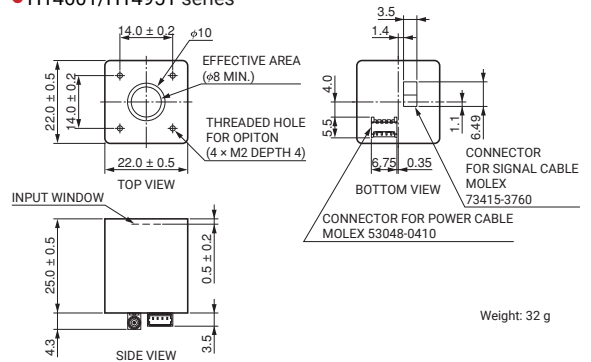

● H14990-100-02

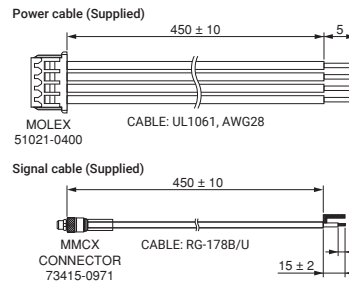
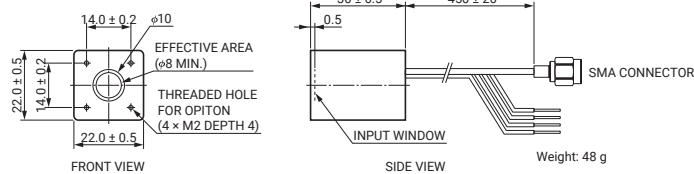

● H14603 series

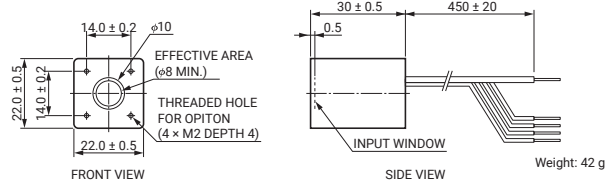

## Signal input/output table

Signal type	H14600	H14601	H14990	H14950	H14951	H14603
	Pin position	Cable	Cable	Pin position	Cable	Cable
Low voltage input (+)	②*1		Red <sup>△</sup> *1	④*3	Red <sup>△</sup> *3	Red <sup>△</sup> *1
Low voltage input (-) *2			—			Green <sup>△</sup>
GND	①		Black <sup>△</sup>	①		Black <sup>△</sup>
Vref output *4	③		Blue <sup>△</sup>	③		Blue <sup>△</sup>
Vcont input *5	⑥		White <sup>△</sup>	⑥		White <sup>△</sup>
Signal output / Signal GND	④ / ⑤		Coaxial <sup>Ⓑ</sup>	④ / ⑤		Coaxial <sup>Ⓑ</sup>

\*1: +5 V  
\*2: -5 V  
\*3: +15 V

\*4: +1.2 V  
\*5: +0.5 V to +1.0 V

<sup>△</sup> UL1061 AWG28  
<sup>Ⓑ</sup> RG-178B/U

# Metal package type photomultiplier tube modules

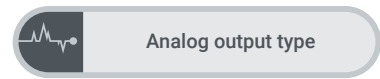

Analog output type

Metal package type photomultiplier tube modules H10720 • H10721 • H11900 • H11901 • H10722 • H10723 • H11902 • H11903 series

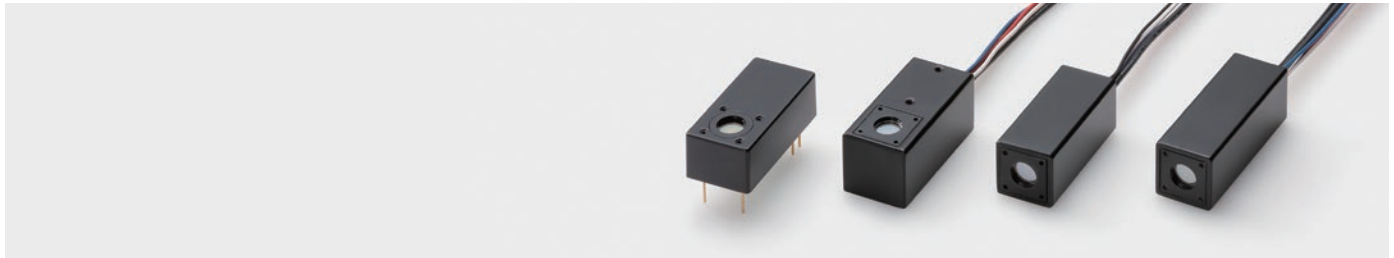

## Product line-up

(at +25 °C)

Parameter	H10720	H10721	H11900	H11901	H10722	H10723	H11902	H11903	Unit
Output	Current output				Voltage output				—
Output type	Pin	Cable	Pin	Cable	Cable				—
Effective area	$\phi 8$								mm
Input voltage	+2.8 to +5.5		+11.5 to +15.5		±4.5 to ±5.5		±11.5 to ±15.5		V
Recommended control voltage adjustment range	+0.5 to +1.1 (Max. +1.1)								V
Settling time <sup>②①</sup>	10		0.2		10		0.2		s
Operating ambient temperature	+5 to +50								°C
Frequency bandwidth	—				DC to 20 kHz	DC to 200 kHz	DC to 20 kHz	DC to 200 kHz	—
Current-to voltage conversion factor	—				1	0.1	1	0.1	V/μA
Maximum output signal voltage <sup>②</sup>	—				+4		+10		V

① The time required for the output to reach a stable level following a change in the control voltage from +1.0 V to +0.5 V

② Load resistance: 10 kΩ

## Specifications of individual products

### • H10720 / H10721 / H11900 / H11901 series

(at +25 °C)



Parameter	-110	-113	-210	-01	-04	-20	Unit
Spectral response	230 to 700	185 to 700	230 to 700	230 to 870	185 to 870	230 to 920	nm
Gain <sup>①</sup>	Typ. $2.0 \times 10^6$						—
Maximum average output signal current	100						μA
Dark current <sup>①</sup>	Typ. 1						nA
P type dark count <sup>①</sup>	Typ. 50						s <sup>-1</sup>

① Control voltage: +1.0 V

### • H10722 / H11902 series

(at +25 °C)

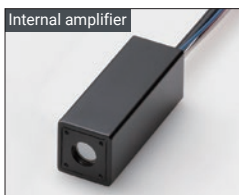

Parameter	-110	-113	-210	-01	-04	-20	Unit
Spectral response	230 to 700	185 to 700	230 to 700	230 to 870	185 to 870	230 to 920	nm
PMT gain <sup>①</sup>	Typ. $2.0 \times 10^6$						—
Voltage output depending on PMT dark current <sup>①</sup>	Typ. 1						mV

① Control voltage: +1.0 V

### • H10723 / H11903 series

(at +25 °C)



Parameter	-110	-113	-210	-01	-04	-20	Unit
Spectral response	230 to 700	185 to 700	230 to 700	230 to 870	185 to 870	230 to 920	nm
PMT gain <sup>①</sup>	Typ. $2.0 \times 10^6$						—
Voltage output depending on PMT dark current <sup>①</sup>	Typ. 0.1						mV

① Control voltage: +1.0 V



## Spectral response

- H10720 / H10721 / H11900 / H11901 series / H10722 / H10723 / H11902 / H11903 series

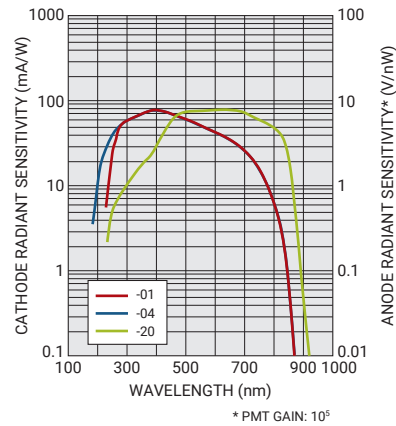
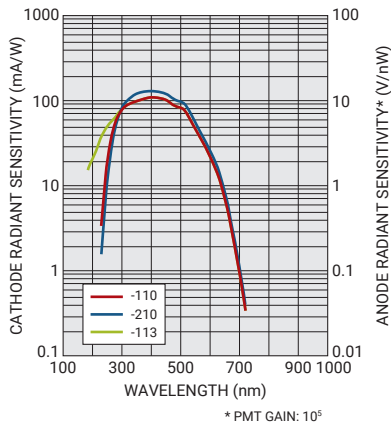

## Dimensional outline (Unit: mm)

- H10720/H11900 series

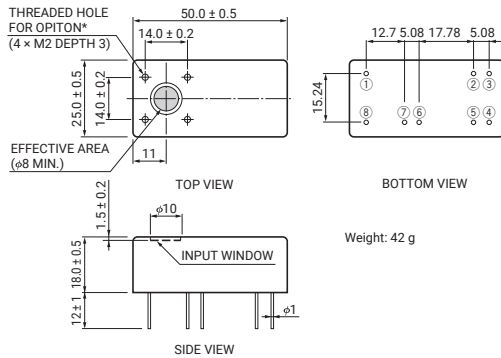

- H10721/H11901 series

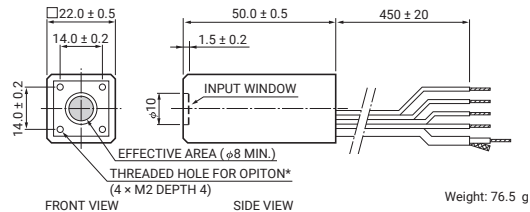

- H10722/H11902 series

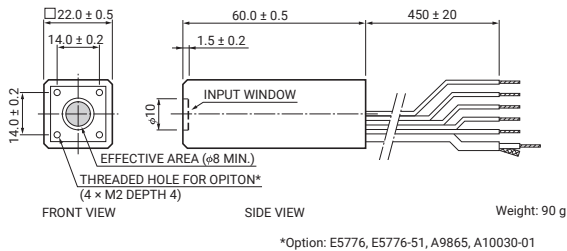

- H10723/H11903 series

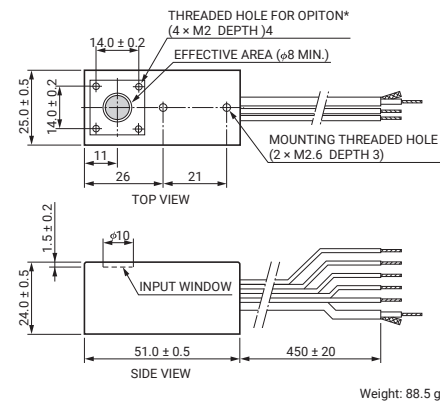

## Signal input/output table

Signal type	H10720	H10721	H11900	H11901	H10722	H10723	H11902	H11903
	Pin position	Cable	Pin position	Cable	Cable	Cable	Cable	Cable
Low voltage input (+)	④*1	Red <sup>Ⓐ</sup> *1	④*3	Red <sup>Ⓐ</sup> *3		Red <sup>Ⓐ</sup> *1		Red <sup>Ⓐ</sup> *3
Low voltage input (-)			—			Green <sup>Ⓐ</sup> *4		Green <sup>Ⓐ</sup> *4
GND	⑤	Black <sup>Ⓐ</sup>	⑤			Black <sup>Ⓐ</sup>		
Vref output *5	②	Blue <sup>Ⓐ</sup>	②			Blue <sup>Ⓐ</sup>		
Vcont input *6	③	White <sup>Ⓐ</sup>	③			White <sup>Ⓐ</sup>		
Signal output / Signal GND	⑦ / ⑥	Coaxial <sup>Ⓑ</sup>	⑦ / ⑥			Coaxial <sup>Ⓑ</sup>		
NC	①, ⑧	—	①, ⑧			—		

\*1: +5 V  
\*2: -5 V  
\*3: +15 V

\*4: -15 V  
\*5: +1.2 V  
\*6: +0.5 V to +1.1 V

Ⓐ UL1430AWG26  
Ⓑ RG-174/U

# Metal package type photomultiplier tube modules with gate function

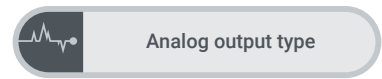

Analog output type

Metal package type photomultiplier tube modules with cooler H11526 • H12056 • H11706 series

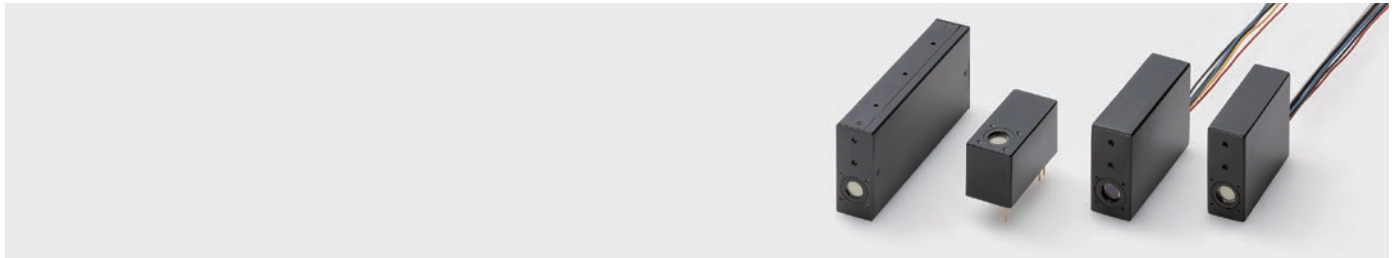

## Product line-up

Parameter		H11526-XX-NN	H11526-XX-NF	H12056	H11706	Unit
Output		Current output				—
Output type		Cable with connector		Pin	Cable	—
Input voltage		+14.5 to +15.5		+4.5 to +5.5	+14.5 to +15.5	V
Settling time		2 <sup>①</sup>		10 <sup>②</sup>	0.2 <sup>②</sup>	s
Gate mode	Mode	Normally ON	Normally OFF	Normally ON	Normally ON	—
	Gate width (FWHM)	100 ns to DC		10 ms to DC	1 μs to 10 ms	—
	Repetition rate	Typ.	10	0.07	10	kHz
	Switching ratio	Typ.	10 <sup>6</sup>	10 <sup>3</sup>	10 <sup>3</sup>	—
Gate signal	Input HIGH level	+3.5 to +5		+2 to +5	+2 to +15	V
	Input impedance	10		10	0.5	kΩ

(at +25 °C)

① The time required for the output to reach a stable level following a change in the control voltage from +0.8 V to +0.4 V

② The time required for the output to reach a stable level following a change in the control voltage: H12056-xx / H11706-xx: from +1.0 V to +0.5 V, H12056-40 / H11706-40: from +0.8 V to +0.5 V

## Specifications of individual products

### • H11526 series

(at +25 °C)



Parameter		-110-NN/-110-NF	-01-NN/-01-NF	-20-NN/-20-NF	Unit
Effective area		φ8			mm
Recommended control voltage adjustment range		+0.4 to +0.9 (Max. +0.9)			V
Spectral response		230 to 700	230 to 870	230 to 920	nm
Gain <sup>①</sup>	Typ.	2.0 × 10 <sup>6</sup>			—
Maximum average output signal current		100			μA
Dark current <sup>①</sup>	Typ.	1	10	10	nA
Operating ambient temperature		+5 to +45			°C

① Control voltage: +0.8 V

### • H12056 series

(at +25 °C)

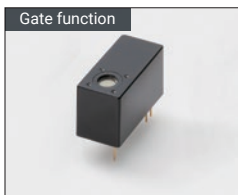

Parameter		-110	-210	-01	-20	-40	Unit
Effective area		φ8			φ5		mm
Recommended control voltage adjustment range		+0.5 to +1.1 (Max. +1.1)			+0.5 to +0.8 (Max. +0.9)		V
Spectral response		230 to 700	230 to 700	230 to 870	230 to 920	300 to 740	nm
Gain	Typ.	2.0 × 10 <sup>6</sup> ①			1.0 × 10 <sup>6</sup> ②③		—
Maximum average output signal current		100			40		μA
Dark current	Typ.	1 <sup>①</sup>	1 <sup>①</sup>	1 <sup>①</sup>	10 <sup>①</sup>	3 <sup>②</sup>	nA
P type dark count		50 <sup>①</sup>	50 <sup>①</sup>	600 <sup>①</sup>	—	6000 <sup>②</sup>	—
Operating ambient temperature		+5 to +50			+5 to +35		°C

① Control voltage: +1.0 V ② Control voltage: +0.8 V ③ P type: 2.0 × 10<sup>6</sup>

### • H11706 series

(at +25 °C)

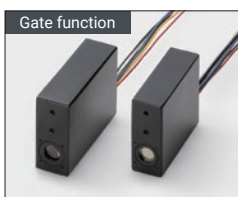

Parameter		-01	-20	-40	Unit
Effective area		φ8		φ5	mm
Recommended control voltage adjustment range		+0.5 to +1.1 (Max. +1.1)		+0.5 to +0.8 (Max. +0.9)	V
Spectral response		230 to 870	230 to 920	300 to 720	nm
Gain	Typ.	2.0 × 10 <sup>6</sup> ①		5.0 × 10 <sup>5</sup> ②	—
Maximum average output signal current		100		2	μA
Dark current	Typ.	1 <sup>①</sup>	10 <sup>①</sup>	5 <sup>②</sup>	nA
P type dark count		600 <sup>①</sup>	—	6000 <sup>②</sup>	—
Operating ambient temperature		+5 to +50		+5 to +35	°C

① Control voltage: +1.0 V ② Control voltage: +0.8 V

## Spectral response

### ● H11526 / H12056 / H11706 series

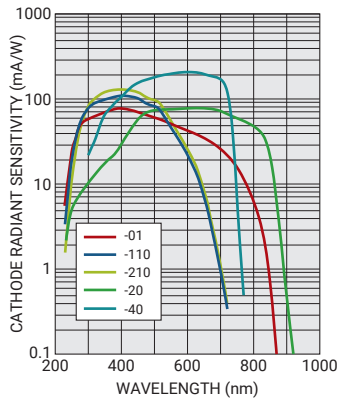

## Gate operation mode

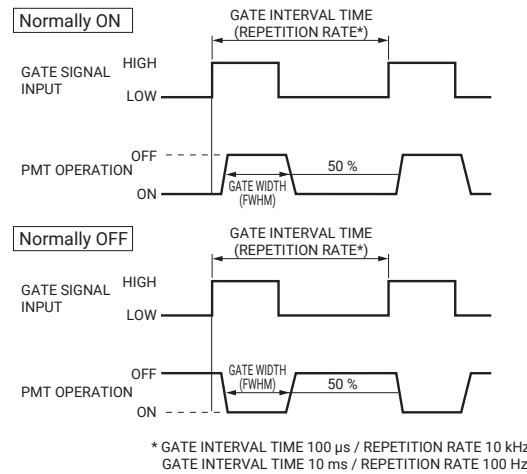

## Dimensional outline (Unit: mm)

### ● H11526 series

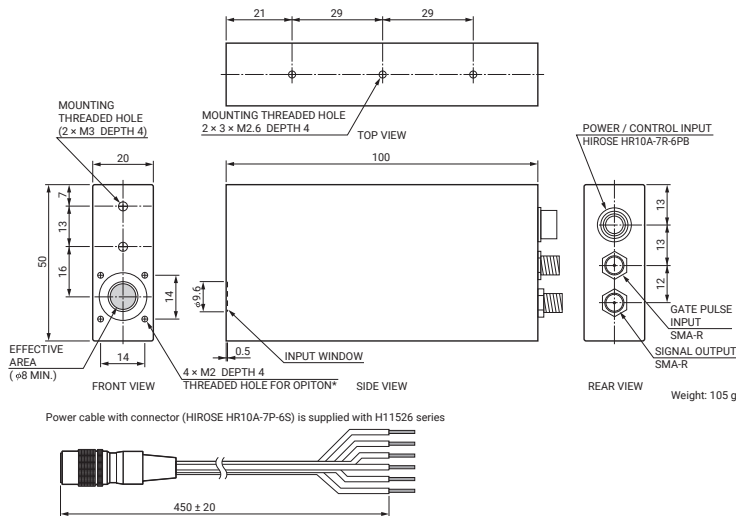

### ● H12056 series

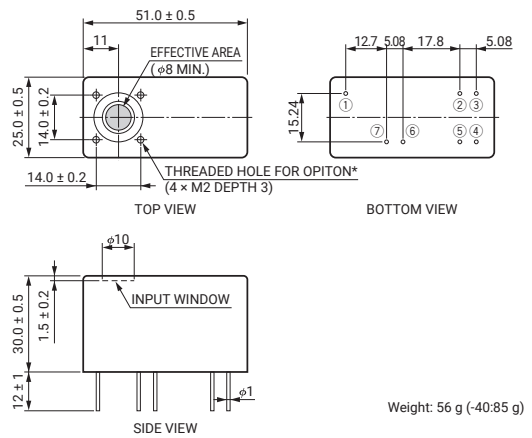

### ● H11706-01/-20

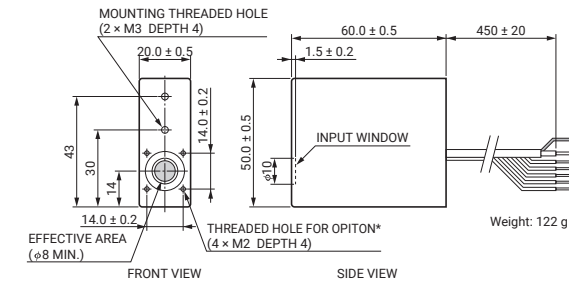

### ● H11706-40

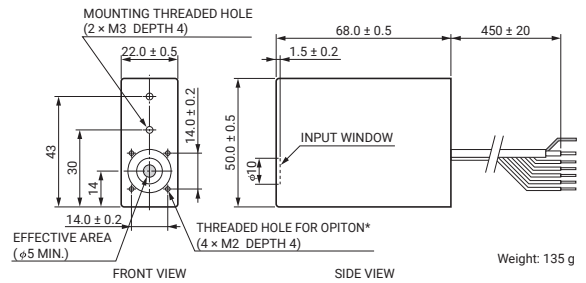

\*Option: E5776, E5776-51, A9865, A10030-01

## ■ Signal input/output table

Signal type	H11526	H12056	H11706
Low voltage input (+)	Cable Red <sup>△</sup> *1	Pin position ④*2	Cable Red <sup>△</sup> *1
GND	Black <sup>△</sup>	⑤	Black <sup>△</sup>
Vref output *3	Blue <sup>△</sup>	②	Blue <sup>△</sup>
Vcont input	White <sup>△</sup> *1	③*5	White <sup>△</sup> *5
Signal output / Signal GND	Coaxial <sup>ⓑ</sup>	⑦ / ⑥	Coaxial <sup>ⓑ</sup>
Gate pulse input	Coaxial <sup>ⓑ</sup>	①	Yellow <sup>△</sup>
Error monitor / Over-light monitor	Yellow <sup>△</sup>		
Operation mode select input	Green <sup>△</sup>		

\*1: +15 V

\*2: +5 V

\*3: +1.2 V

\*4: +0.4 V to +0.9 V

\*5: +0.5 V to +1.1 V (except for -40)  
 +0.5 V to +0.8 V (-40)

<sup>△</sup> Attached power cable (HIROSE HR10A-7P-6S)

<sup>ⓑ</sup> SMA-R

<sup>Ⓒ</sup> UL1430 AWG26

<sup>Ⓓ</sup> RG-174/U

# Metal package type photomultiplier tube modules with cooler

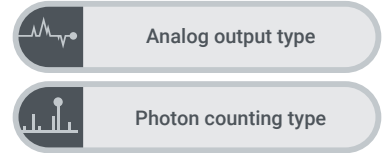

photomultiplier tube modules H7422 series, Photon counting heads H7421 series



## Product line-up

(at +25 °C)

Parameter	H7422	H7421	Unit
Output	Current output	Photon counting	—
Output type	Cable with connector		—
Effective area	φ5		mm
Input voltage	+11.5 to +15.5	+4.5 to +5.5	V
Operating ambient temperature	+5 to +35		°C
Cooling	Thermoelectric cooling		—
specifications	Max. cooling temperature (ΔT)	35	°C
	Cooling time	approx. 5	min

## Specifications of individual products

### • H7422 series

(at +25 °C)



Parameter	-40	P-40	-50	P-50	Unit	
Spectral response	300 to 740		380 to 900		nm	
Recommended control voltage adjustment range	+0.5 to +0.8 (Max. +0.9)				V	
Gain <sup>①</sup>	Typ.	1.0 × 10 <sup>6</sup>	2.0 × 10 <sup>6</sup>	1.0 × 10 <sup>6</sup>	2.0 × 10 <sup>6</sup>	—
Maximum average output signal current	2				μA	
Dark current <sup>①②</sup>	Typ.	0.4	—	0.5	—	nA
P type dark count <sup>①②③</sup>	Typ.	—	100	—	125	s <sup>-1</sup>
Settling time <sup>④</sup>	0.2				s	
Over light protection <sup>⑤</sup>	10				μA	

① Control voltage: +0.8 V    ② at 0 °C    ③ Control voltage: Plateau voltage  
 ④ The time required for the output to reach a stable level following a change in the control voltage from +0.9 V to +0.5 V  
 ⑤ We also provide "A type" that over light protective function works at 50 μA.

### • H7421 series

(at +25 °C)



Parameter	-40	-50	Unit	
Spectral response	300 to 740	380 to 900	nm	
Count linearity	1.5 × 10 <sup>6</sup>		s <sup>-1</sup>	
Pulse-pair resolution	70		ns	
Output pulse width	Typ.	30	ns	
Output pulse Height <sup>①</sup>	Typ.	+3.0	V	
Recommended load resistance	50		Ω	
Dark count	Typ.	100	125	s <sup>-1</sup>

① Load resistance: : 50 Ω

## Compatible options

Parameter	H7422	H7421
Heatsink with fan	A7423	
Signal cable	E1168-05	
Optical fiber adapter	A7412	
C-mount adapter	A7413	
Power supply unit with temperature control (AC100 V to 240 V input)	C8137-02	C8137



## Spectral response

### ● H7422 series

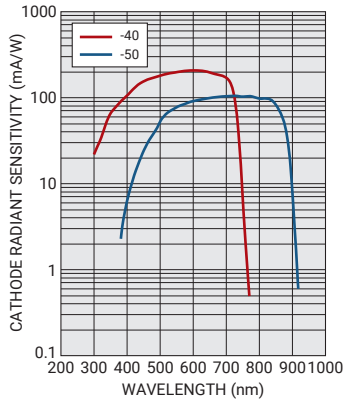

## Count sensitivity

### ● H7421 series

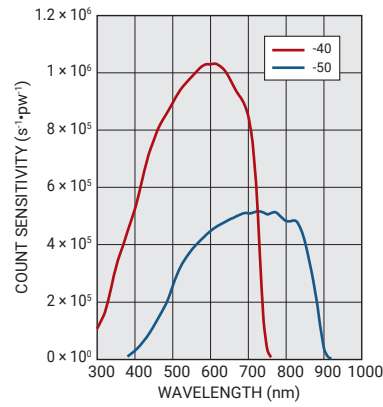

## Dimensional outline (Unit: mm)

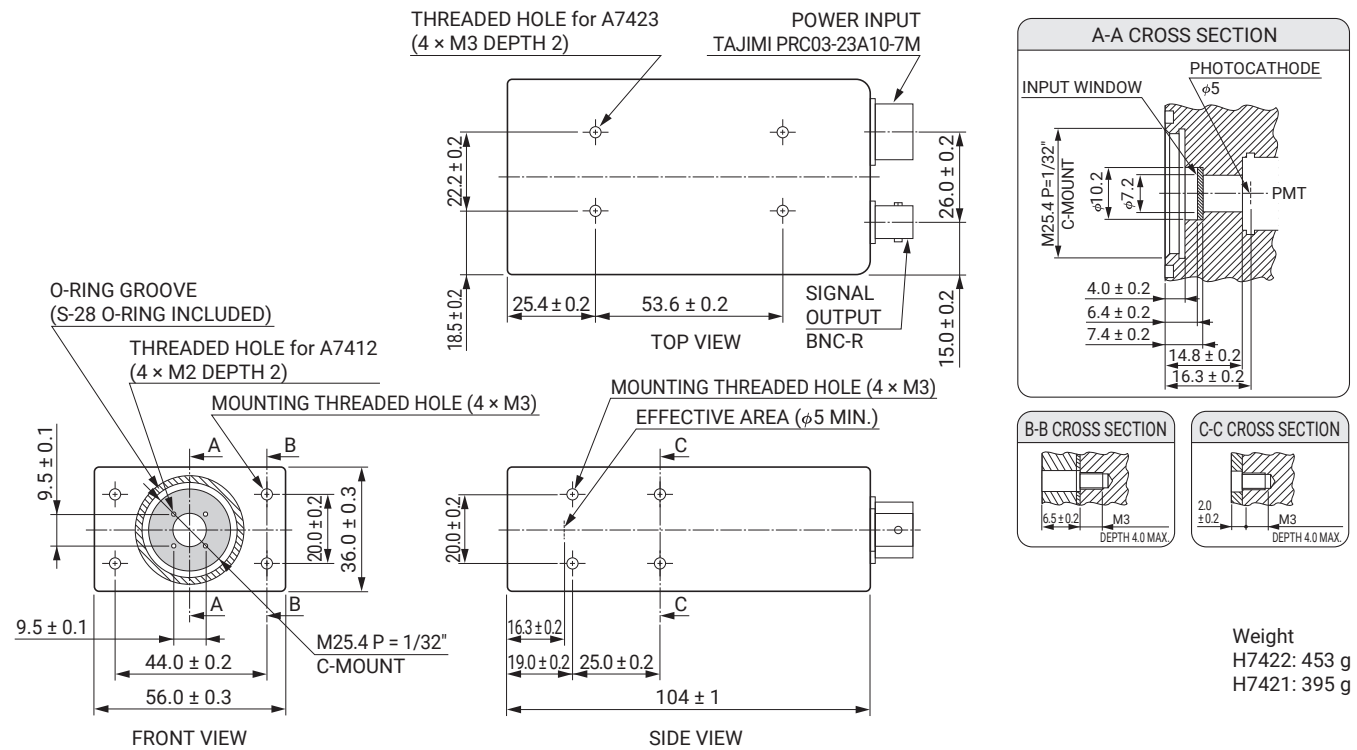

Weight  
H7422: 453 g  
H7421: 395 g

## CONNECTOR

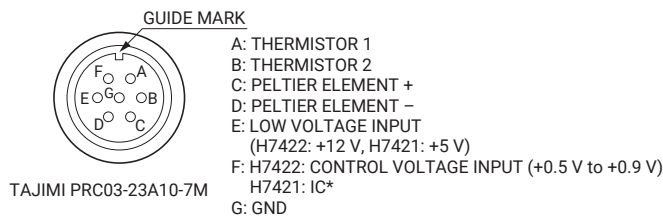

\* IC: Internal Connection (Do not use)

# Side-on type photomultiplier tube modules

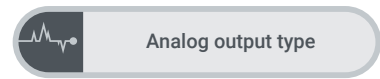

Analog output type

photomultiplier tube modules H9305 • H13320 • H9306 • H9307 series

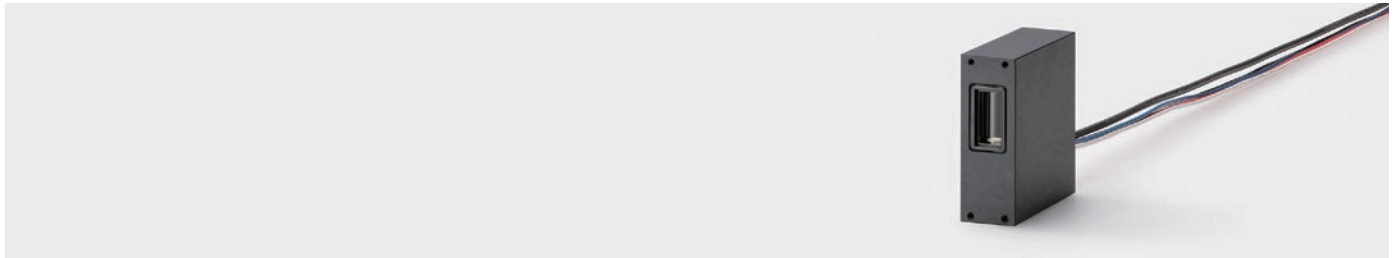

## Product line-up

(at +25 °C)

Parameter	H9305	H13320	H9306	H9307	Unit
Output	Current output		Voltage output		—
Output type	Cable				—
Effective area	3.7 × 13.0				mm
Input voltage	+11.5 to +15.5	+2.8 to +5.5	±11.5 to ±15.5		V
Recommended control voltage adjustment range	+0.25 to +1.0 (Max. 1.2)				V
Settling time <sup>①</sup>	10	14	10		s
Operating ambient temperature	+5 to +50				°C

<sup>①</sup> The time required for the output to reach a stable level following a change in the control voltage from +1.0 V to +0.5 V

## Specifications of individual products

### • H9305 series / H13320 series

(at +25 °C)



Parameter	-01	-02	-03	-13	-04	-05	-09	Unit
Spectral response	185 to 750	185 to 900	185 to 900	185 to 900	185 to 830	185 to 650	160 to 320	nm
Gain <sup>①</sup>	Typ. 5.8 × 10 <sup>6</sup>	4.0 × 10 <sup>6</sup>	4.0 × 10 <sup>6</sup>	2.3 × 10 <sup>6</sup>	3.5 × 10 <sup>6</sup>	7.5 × 10 <sup>6</sup>	4.0 × 10 <sup>6</sup>	—
Maximum average output signal current	10							μA
Dark current <sup>①</sup>	Typ. 1	1	2	3	0.1	0.5	0.5	nA

<sup>①</sup> Control voltage: +1.0 V

### • H9306 series

(at +25 °C)



Parameter	-01	-02	-03	-13	-04	-05	-09	Unit
Spectral response	185 to 750	185 to 900	185 to 900	185 to 900	185 to 830	185 to 650	185 to 320	nm
PMT gain <sup>①</sup>	Typ. 5.8 × 10 <sup>6</sup>	4.0 × 10 <sup>6</sup>	4.0 × 10 <sup>6</sup>	2.3 × 10 <sup>6</sup>	3.5 × 10 <sup>6</sup>	7.5 × 10 <sup>6</sup>	4.0 × 10 <sup>6</sup>	—
Frequency bandwidth	DC to 20							kHz
Current-to voltage conversion factor	1							V/μA
Maximum output signal voltage	+10 <sup>②</sup>							V
Voltage output depending on PMT dark current <sup>①</sup>	Typ. 1	1	2	3	0.1	0.5	0.5	mV

<sup>①</sup> Control voltage: +1.0 V

<sup>②</sup> Load resistance: 10 kΩ

### • H9307 series

(at +25 °C)



Parameter	-01	-02	-03	-13	-04	-05	-09	Unit
Spectral response	185 to 750	185 to 900	185 to 900	185 to 900	185 to 830	185 to 650	185 to 320	nm
PMT gain <sup>①</sup>	Typ. 5.8 × 10 <sup>6</sup>	4.0 × 10 <sup>6</sup>	4.0 × 10 <sup>6</sup>	2.3 × 10 <sup>6</sup>	3.5 × 10 <sup>6</sup>	7.5 × 10 <sup>6</sup>	4.0 × 10 <sup>6</sup>	—
Frequency bandwidth	DC to 200							kHz
Current-to voltage conversion factor	0.1							V/μA
Maximum output signal voltage	+1 <sup>②</sup>							V
Voltage output depending on PMT dark current <sup>①</sup>	Typ. 0.1	0.1	0.2	0.3	0.01	0.05	0.05	mV

<sup>①</sup> Control voltage: +1.0 V

<sup>②</sup> Load resistance: 10 kΩ

## Spectral response

### ● H9305 / H13320 series

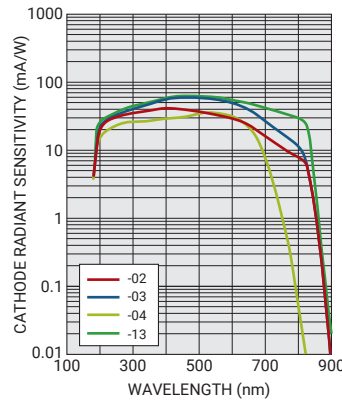
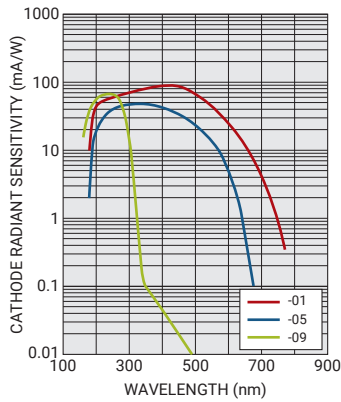

### ● H9306 series

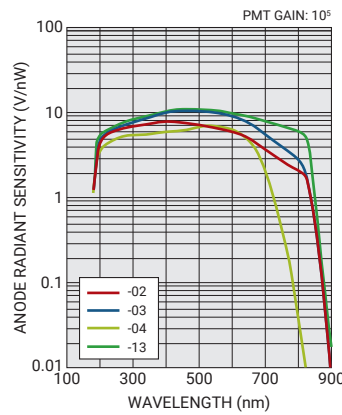
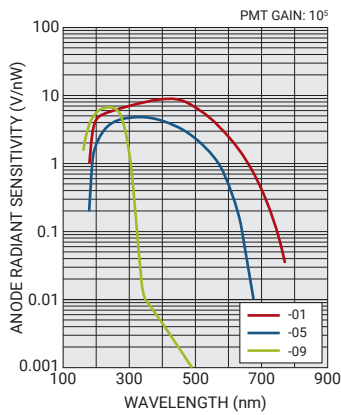

### ● H9307 series

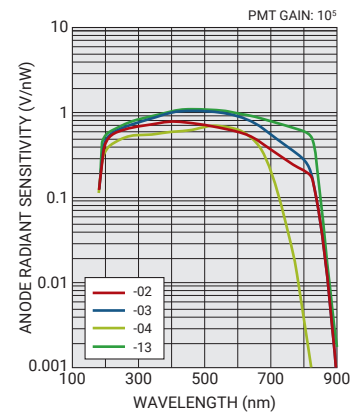
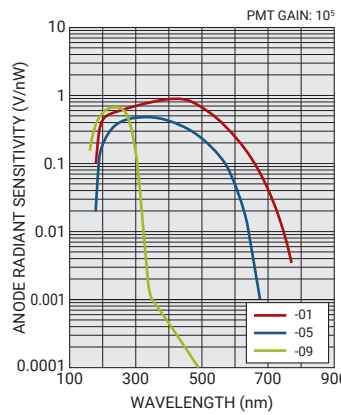

## Dimensional outline (Unit: mm)

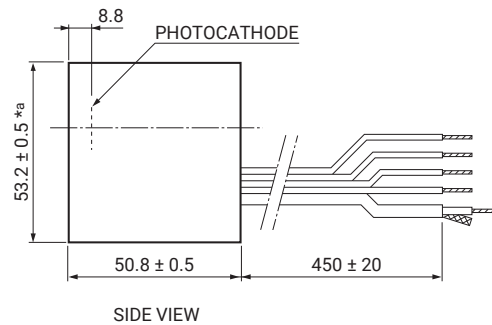
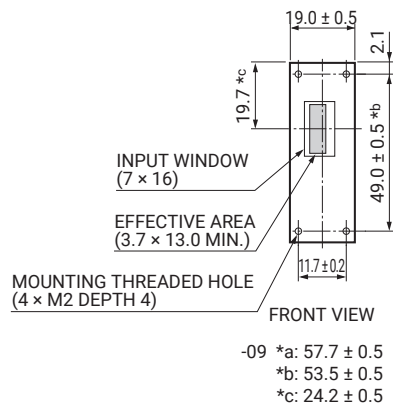

Weight: H9305/H9306/H9307 (except for -09) 110 g  
 H13320 (except for -09) 105 g  
 -09 115 g

## ■ Signal input/output table

Signal type	H9305	H13320	H9306	H9307
Low voltage input (+)	Cable Red <sup>Ⓐ</sup> *1	Cable Red <sup>Ⓐ</sup> *2	Cable	Cable Red <sup>Ⓐ</sup> *1
Low voltage input (-)				Green <sup>Ⓐ</sup> *3
GND			Black <sup>Ⓐ</sup>	
Vref output *4			Blue <sup>Ⓐ</sup>	
Vcont input *5			White <sup>Ⓐ</sup>	
Signal output / Signal GND			Coaxial <sup>Ⓑ</sup>	

\*1: +15 V  
 \*2: +5 V  
 \*3: -15 V

\*4: +1.2 V  
 \*5: +0.25 V to +1.0 V

Ⓐ UL1430 AWG26  
 Ⓑ RG-174/U

# Side-on type photomultiplier tube modules

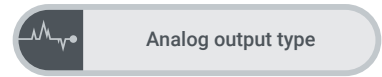

Analog output type

photomultiplier tube modules H11461 • H11462 series

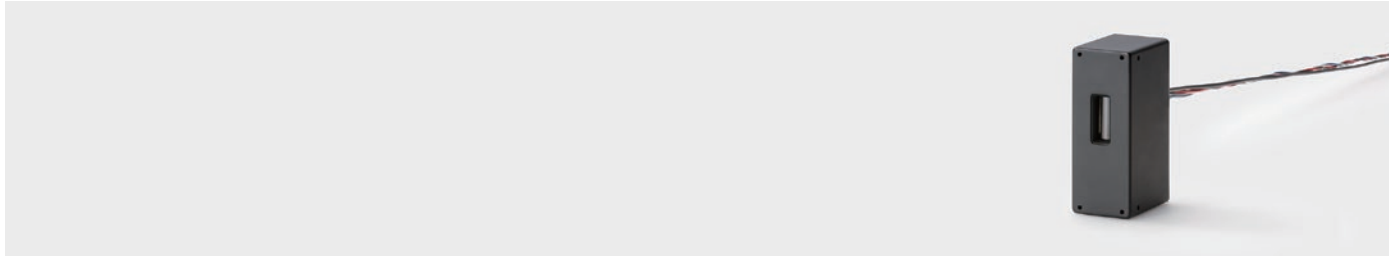

## Product line-up

(at +25 °C)

Parameter	H11461	H11462	Unit
Output	Current output	Voltage output	—
Output type	Cable		—
Effective area	4 × 20		mm
Input voltage	+4.5 to +5.5	±4.5 to ±5.5	V
Recommended control voltage adjustment range	+0.5 to +1.1 (Max. 1.2)		V
Settling time <sup>①</sup>	14		s
Operating ambient temperature	+5 to +50		°C

<sup>①</sup> The time required for the output to reach a stable level following a change in the control voltage from +1.0 V to +0.5 V

## Specifications of individual products

### ● H11461 series

(at +25 °C)



Parameter	-01	-02	-03	-09	P-01	P-11	Unit
Spectral response	185 to 710	185 to 900	185 to 900	185 to 320	185 to 710	185 to 850	nm
Gain <sup>①</sup>	Typ. $1.2 \times 10^7$	$1.0 \times 10^7$	$9.5 \times 10^6$	$1.0 \times 10^7$	$1.2 \times 10^7$	$3.5 \times 10^6$	—
Maximum average output signal current	100						μA
Dark current <sup>①</sup>	Typ. 0.2	3	10	1	0.1	0.2	nA
Dark count	—	—	—	—	30	80	s <sup>-1</sup>

<sup>①</sup> Control voltage: +1.0 V

### ● H11462 series

(at +25 °C)



Parameter	-011	-012	-021	-022	-031	-032	Unit
Spectral response	185 to 710		185 to 900		185 to 900		nm
PMT gain <sup>①</sup>	Typ. $1.2 \times 10^7$		$1.0 \times 10^7$		$9.5 \times 10^6$		—
Frequency bandwidth	Max. 20	200	20	200	20	200	kHz
Current-to voltage conversion factor	1	0.1	1	0.1	1	0.1	V/μA
Maximum output signal voltage	+4 <sup>②</sup>						V
Voltage output depending on PMT dark current <sup>①</sup>	Typ. 0.2	0.02	3	0.3	10	1	mV

<sup>①</sup> Control voltage: +1.0 V

<sup>②</sup> Load resistance: 10 kΩ



## Spectral response

### ● H11461 series

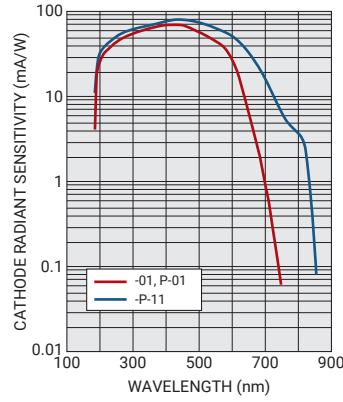
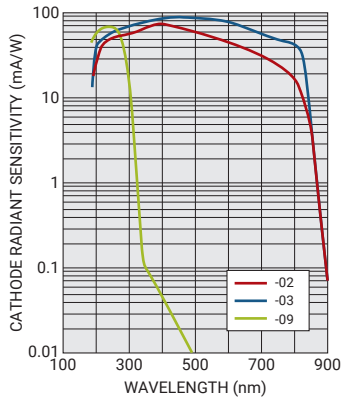

### ● H11462-011 / -021 / -031

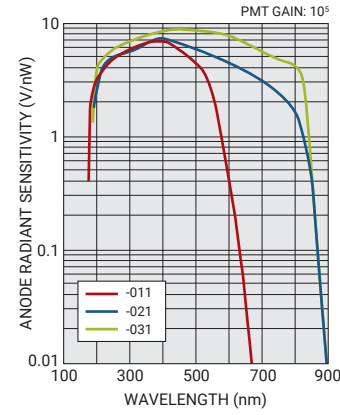

### ● H11462-012 / -022 / -032

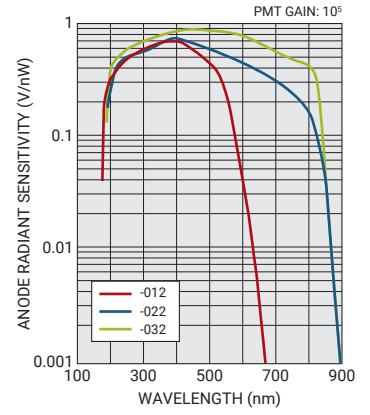

## Dimensional outline (Unit: mm)

### ● H11461 / H11462 series

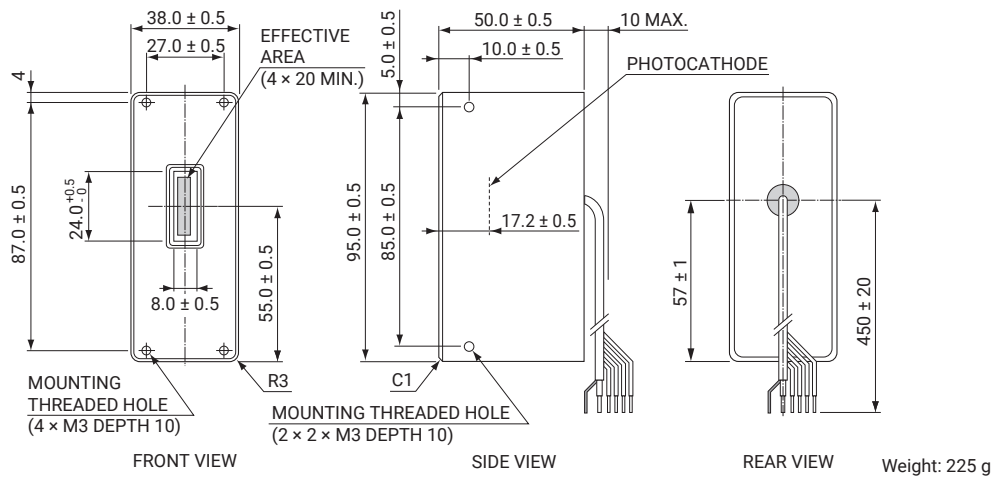

## ■ Signal input/output table

Signal type	H11461	H11462
	Cable	Cable
Low voltage input (+) *1		Red <sup>Ⓐ</sup>
Low voltage input (-) *2	—	Green <sup>Ⓐ</sup>
GND		Black <sup>Ⓐ</sup>
Vref output *3		Blue <sup>Ⓐ</sup>
Vcont input *4		White <sup>Ⓐ</sup>
Signal output / Signal GND		Coaxial <sup>Ⓑ</sup>

\*1: +5 V

\*2: -5 V

\*3: +1.2 V

\*4: +0.25 V to +1.1 V

<sup>Ⓐ</sup> UL1430 AWG26

<sup>Ⓑ</sup> RG-174/U

# Side-on type photomultiplier tube module with cooler

Analog output type

photomultiplier tube modules H14768

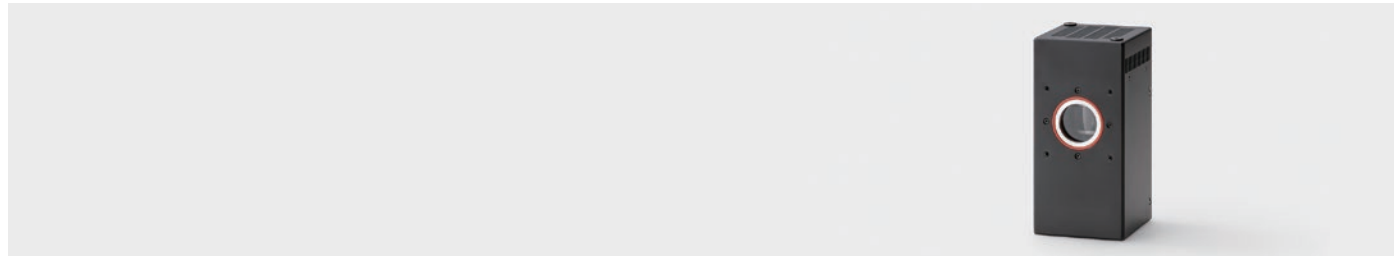

## Specifications

(at +25 °C)

Parameter	H14768	Unit
Output	Current output	—
Output type	Connector	—
Spectral response	185 to 900	nm
Effective area	10 × 14	mm
Input voltage	+11.5 to +15.5	V
Recommended control voltage adjustment range	+0.2 to +1.2 (Max. +1.2)	V
Gain <sup>①</sup>	Typ. 6.7 × 10 <sup>6</sup>	—
Maximum average output signal current	58	μA
Dark current <sup>①②</sup>	Typ. 0.08	nA
Cooling specifications	Thermoelectric cooling	—
Cooling method	Thermoelectric cooling	—
Cooling temperature (ΔT)	30	°C
Thermal equilibrium arrival time	20	min
Settling time <sup>③</sup>	10	s
Operating ambient temperature	+5 to +35	°C

① Control voltage: +1.0 V

② At 0 °C

③ The time required for the output to reach a stable level following a change in the control voltage from +1.0 V to +0.5 V

## Spectral response

● H14768

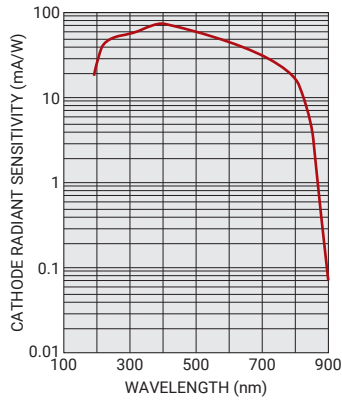

## Dimensional outline (Unit: mm)

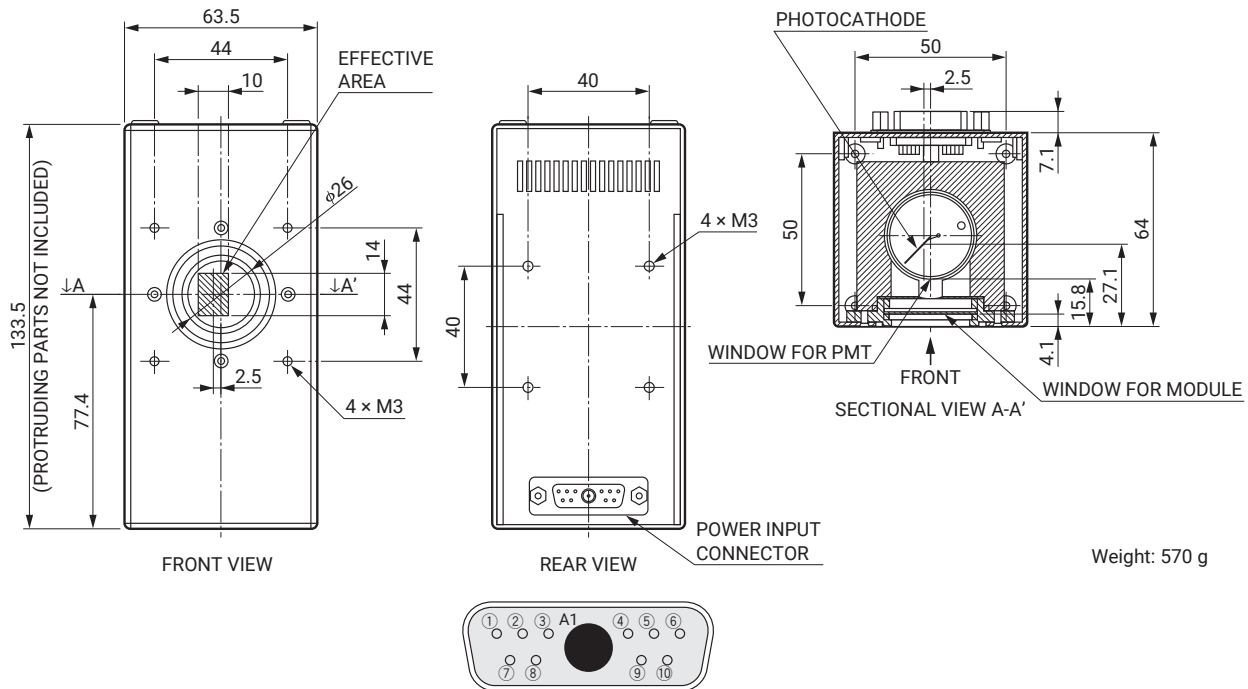

## Signal input/output table

Signal type	H14768
	Pin position
Input for divider & HVPS (+15 V)	①
Input for divider & HVPS (GND)	②
Temp. sensor output (GND)	③
Temp. sensor output (+2.500 V to +3.082 V)	④
Peltier power input (CC)	⑤
Peltier power input (GND)	⑥
Vcont. Input (+0.2 V to +1.2 V)	⑦
Vref. Output (+1.25 V)	⑧
Fan power input (+12 V)	⑨
Fan power input (GND)	⑩
PMT signal output / Coax type	A1

# Head-on type photomultiplier tube modules

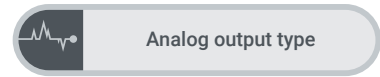

Analog output type

photomultiplier tube modules H7826 • H7827 • H13543 series

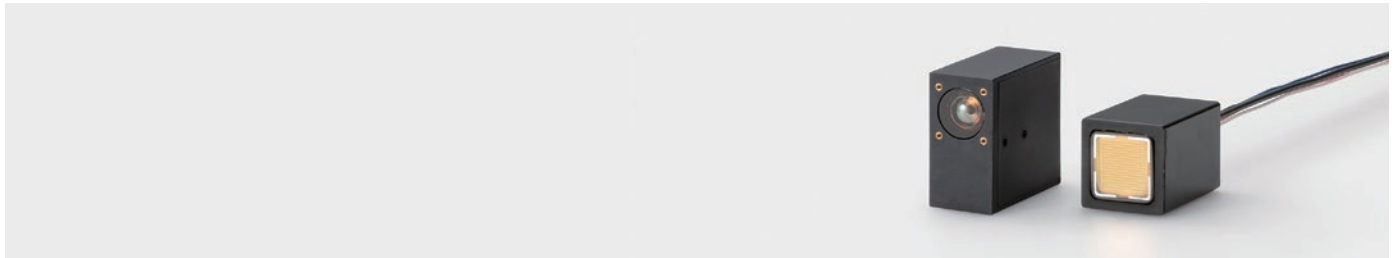

## Product line-up

(at +25 °C)

Parameter	H7826	H7827	H13543	Unit
Output	Current output	Voltage output	Current output	—
Output type	Cable			—
Effective area	φ15		18 × 18	mm
Input voltage	+11.5 to +15.5	±11.5 to ±15.5	+4.5 to +5.5	V
Recommended control voltage adjustment range	+0.5 to +1.1 (Max. 1.2)		+0.4 to +0.8 (Max. 0.9)	V
Settling time	0.2 <sup>①</sup>		10 <sup>②</sup>	s
Operating ambient temperature	+5 to +45		+5 to +50	°C

- ① The time required for the output to reach a stable level following a change in the control voltage from +1.0 V to +0.5 V  
 ② The time required for the output to reach a stable level following a change in the control voltage from +0.8 V to +0.4 V

## Specifications of individual products

### • H7826 series

(at +25 °C)



Parameter	H7826	H7826-01	H7826P	H7826P-01	Unit
Spectral response	300 to 650	300 to 850	300 to 650	300 to 850	nm
Gain <sup>①</sup>	Typ. $5.5 \times 10^5$	$2.5 \times 10^5$	$1.8 \times 10^6$	$1.0 \times 10^6$	—
Maximum average output signal current	100				μA
Dark current <sup>①</sup>	Typ.	3			nA
Dark count		—	200	2000	s <sup>-1</sup>

① Control voltage: +1.0 V

### • H7827 series

(at +25 °C)



Parameter	-001	-002	-011	-012	Unit	
Spectral response	300 to 650		300 to 850		nm	
PMT gain <sup>①</sup>	Typ.	$5.5 \times 10^5$		$2.5 \times 10^5$	—	
Frequency bandwidth	Max.	20	200	20	200	kHz
Current-to voltage conversion factor		1	0.1	1	0.1	V/μA
Maximum output signal voltage <sup>②</sup>	+10				V	
Voltage output depending on PMT dark current <sup>①</sup>	Typ.	3	0.3	3	0.3	mV

- ① Control voltage: +1.0 V  
 ② Load resistance: 10 kΩ

### • H13543 series

(at +25 °C)



Parameter	H13543	H13543-01	H13543-03	H13543-20	H13543-100	H13543-200	H13543-300	Unit
Spectral response	300 to 650	300 to 880	185 to 650	300 to 920	300 to 650	300 to 650	300 to 700	nm
Gain <sup>①</sup>	Typ. $2.0 \times 10^6$	$1.0 \times 10^6$	$2.0 \times 10^6$	$1.0 \times 10^6$	$2.0 \times 10^6$			—
Maximum average output signal current	100							μA
Dark current <sup>①</sup>	Typ.	2	10	2	20	2		nA

① Control voltage: +0.8 V



## Spectral response

### • H7826 series

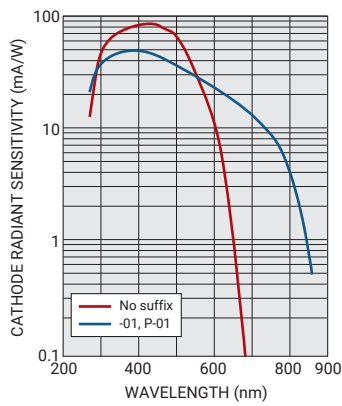

### • H7827-001 / -011

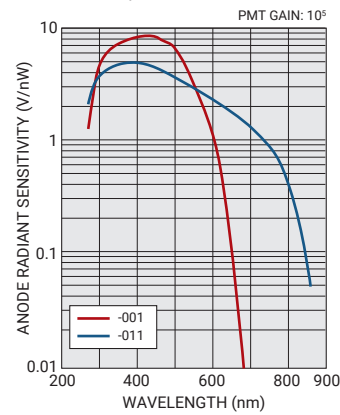

### • H7827-002 / -012

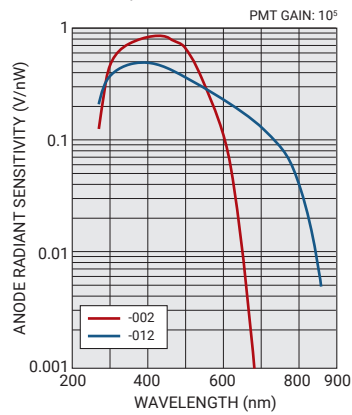

### • H13543 series

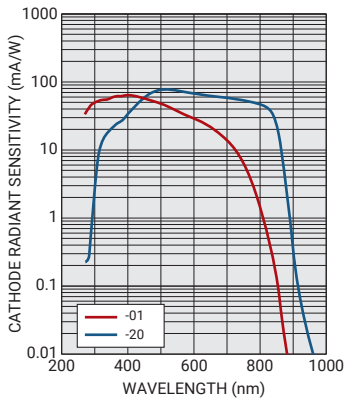
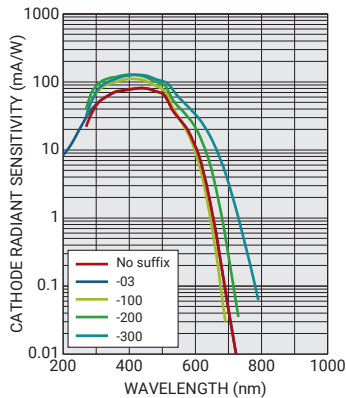

## Dimensional outline (Unit: mm)

### • H7826 / H7827 series

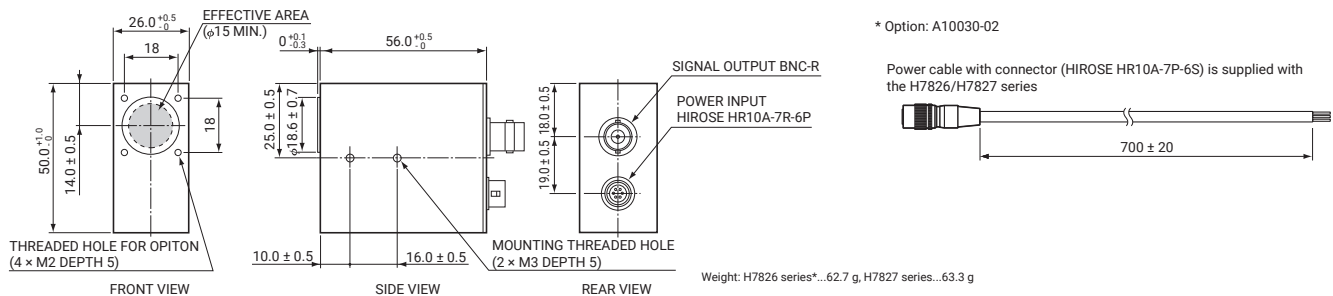

### • H13543 series

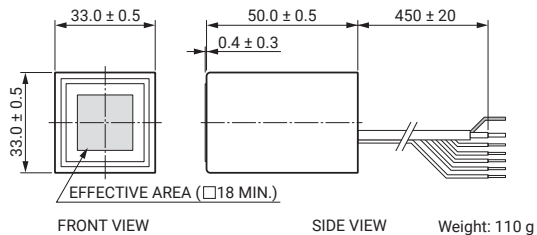

## ■ Signal input/output table

Signal type	H7826	H7827	H13543
	Cable	Cable	Cable
Low voltage input (+)		Red <sup>A*1</sup>	Red <sup>C*2</sup>
Low voltage input (-) <sup>*3</sup>	—	Green <sup>A</sup>	—
GND		Black <sup>A</sup>	Black <sup>C</sup>
Vref output <sup>*4</sup>		Blue <sup>A</sup>	Blue <sup>C</sup>
Vcont input		White <sup>A*5</sup>	White <sup>C*6</sup>
Signal output / Signal GND		Coaxial <sup>B</sup>	Coaxial <sup>D</sup>
NC	Green <sup>A</sup>	—	—

\*1: +15 V  
\*2: +5 V

\*3: -15 V  
\*4: +1.2 V

\*5: +0.5 V to +1.1 V  
\*6: +0.4 V to +0.8 V

<sup>A</sup> Attached power cable (HIROSE HR10A-7P-6S)  
<sup>B</sup> BNC-R

<sup>C</sup> UL1430 AWG26  
<sup>D</sup> RG-174/U

# Head-on type photomultiplier tube modules

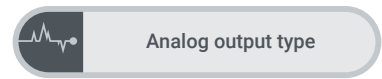

Analog output type

photomultiplier tube modules H10425 • H10492 • H10426 • H10493 series

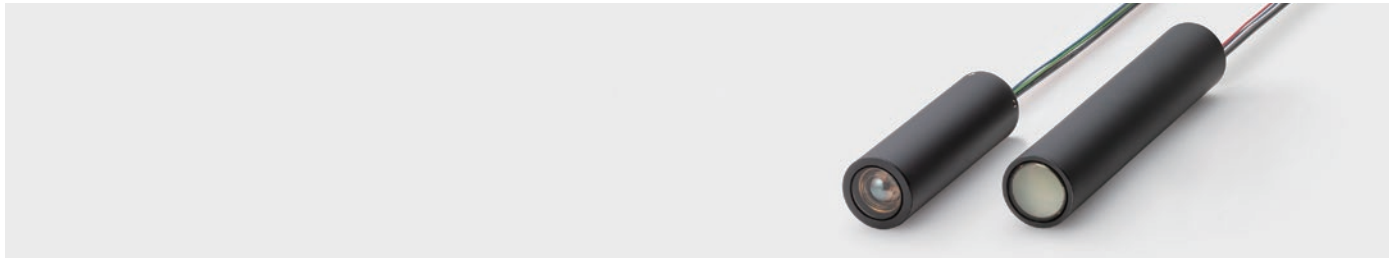

## Product line-up

(at +25 °C)

Parameter	H10425	H10492	H10426	H10493	Unit
Output	Current output	Voltage output	Current output	Voltage output	—
Output type	Cable				—
Effective area	φ22		φ25		mm
Input voltage	+11.5 to +15.5	±11.5 to ±15.5	+11.5 to +15.5	±11.5 to ±15.5	V
Recommended control voltage adjustment range	+0.5 to +1.1 (Max. 1.2)		+0.5 to +1.4 (Max. 1.4)		V
Settling time <sup>①</sup>	10				s
Operating ambient temperature	+5 to +50				°C

① The time required for the output to reach a stable level following a change in the control voltage from +1.0 V to +0.5 V

## Specifications of individual products

### • H10425 series

(at +25 °C)



Parameter	H10425	H10425-01	Unit
Spectral response	300 to 650	300 to 850	nm
Gain <sup>①</sup>	Typ. 2.0 × 10 <sup>6</sup>	5.0 × 10 <sup>5</sup>	—
Maximum average output signal current	100		μA
Dark current <sup>①</sup>	Typ. 3		nA

① Control voltage: +1.0 V

### • H10492 series

(at +25 °C)



Parameter	-001	-002	-003	-011	-012	-013	Unit
Spectral response	300 to 650			300 to 850			nm
PMT gain <sup>①</sup>	Typ. 2.0 × 10 <sup>6</sup>			5.0 × 10 <sup>5</sup>			—
Frequency bandwidth	Max. 20	200	8000	20	200	8000	kHz
Current-to voltage conversion factor	1	0.1	0.1	1	0.1	0.1	V/μA
Maximum output signal voltage	+10 <sup>②</sup>		+10 <sup>③</sup> , +5 <sup>④</sup>	+10 <sup>②</sup>		+10 <sup>③</sup> , +5 <sup>④</sup>	V
Voltage output depending on PMT dark current <sup>①</sup>	Typ. 3	0.3	0.3	3	0.3	0.3	mV

① Control voltage: +1.0 V    ② Load resistance: 10 kΩ    ③ Load resistance: 500 kΩ    ④ Load resistance: 50 Ω

### • H10426 series

(at +25 °C)



Parameter	H10426	H10426-01	Unit
Spectral response	300 to 650	185 to 850	nm
Gain <sup>①</sup>	Typ. 2.1 × 10 <sup>6</sup>	5.3 × 10 <sup>5</sup>	—
Maximum average output signal current	100		μA
Dark current <sup>①</sup>	Typ. 2	3	nA

① Control voltage: +1.0 V

### • H10493 series

(at +25 °C)



Parameter	-001	-002	-003	-011	-012	-013	Unit
Spectral response	300 to 650			185 to 850			nm
PMT gain <sup>①</sup>	Typ. 2.1 × 10 <sup>6</sup>			5.3 × 10 <sup>5</sup>			—
Frequency bandwidth	Max. 20	200	8000	20	200	8000	kHz
Current-to voltage conversion factor	1	0.1	0.1	1	0.1	0.1	V/μA
Maximum output signal voltage	+10 <sup>②</sup>		+10 <sup>③</sup> , +5 <sup>④</sup>	+10 <sup>②</sup>		+10 <sup>③</sup> , +5 <sup>④</sup>	V
Voltage output depending on PMT dark current <sup>①</sup>	Typ. 2	0.2	0.2	3	0.3	0.3	mV

① Control voltage: +1.0 V    ② Load resistance: 10 kΩ    ③ Load resistance: 500 kΩ    ④ Load resistance: 50 Ω

## Spectral response

● H10425 / H10426 series

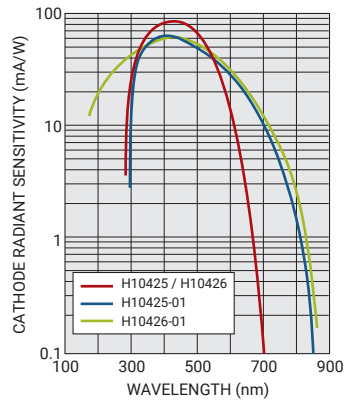

● H10492-001 / -011, H10493-001 / -011

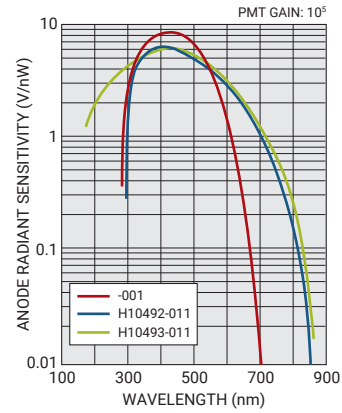

● H10492-002 / -012 / -003 / -013  
H10493-002 / -012 / -003 / -013

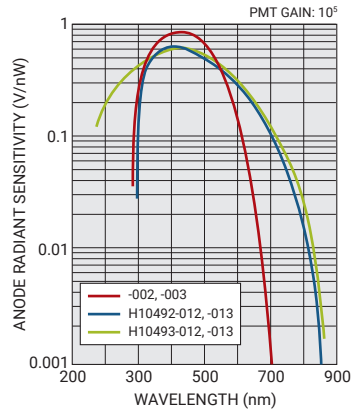

## Dimensional outline (Unit: mm)

● H10425 / H10492 series

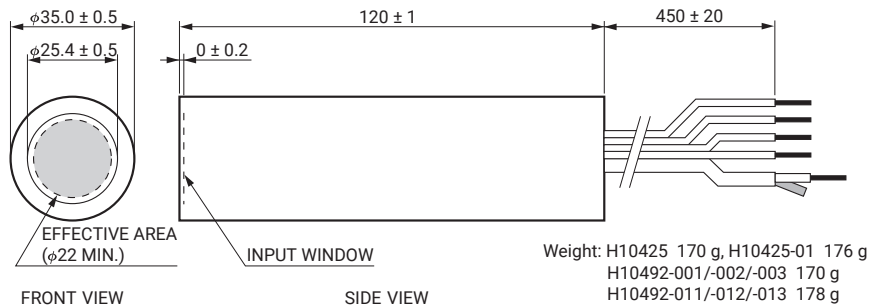

● H10426 / H10493 series

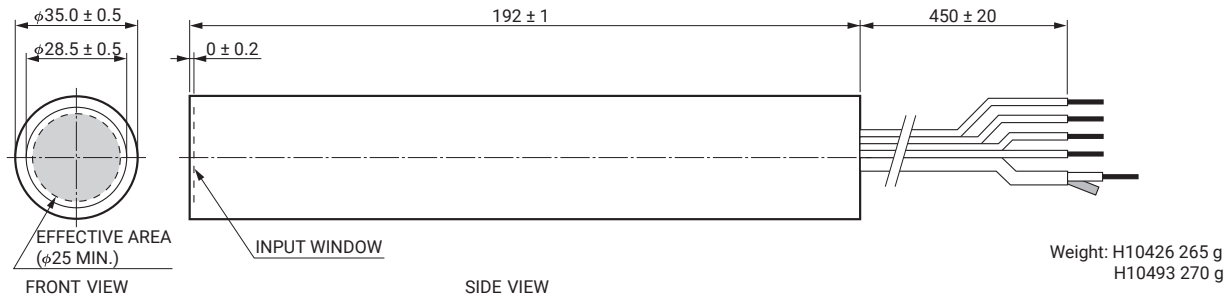

## Signal input/output table

Signal type	H10425	H10492	H10426	H10493
	Cable	Cable	Cable	Cable
Low voltage input (+) *1		Red <sup>(A)</sup>		
Low voltage input (-) *2	-	Green <sup>(A)</sup>	-	Green <sup>(A)</sup>
GND		Black <sup>(A)</sup>		
Vref output		Blue <sup>(A)*3</sup>		Blue <sup>(A)*4</sup>
Vcont input		White <sup>(A)*5</sup>		White <sup>(A)*6</sup>
Signal output / Signal GND		Coaxial <sup>(B)</sup>		

\*1: +15 V

\*2: -15 V

\*3: +1.2 V

\*4: +2.5 V

\*5: +0.5 V to +1.1 V

\*6: +0.5 V to +1.4 V

(A) UL1430 AWG26

(B) RG-174/U

# Head-on type photomultiplier tube modules

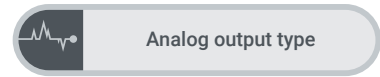

Analog output type

photomultiplier tube modules H14447 • H11411 • H11432 series

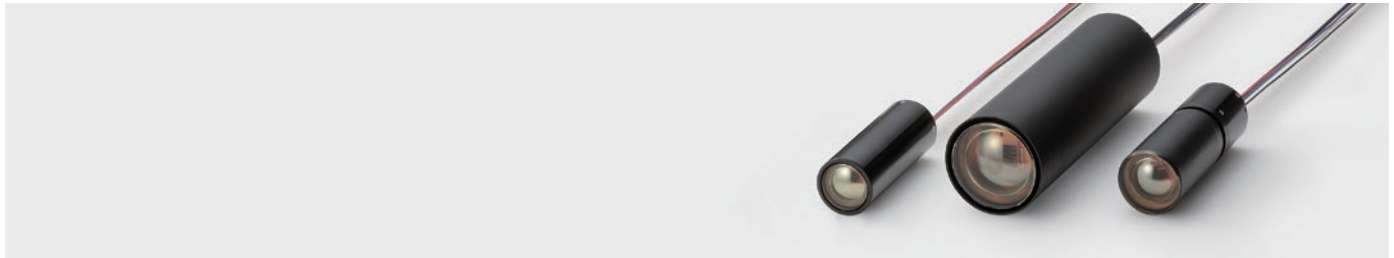

## Product line-up

(at +25 °C)

Parameter	H14447	H11411	H11432	Unit
Output	Current output			—
Output type	Cable			—
Effective area	φ25	φ46	φ34	mm
Input voltage	+4.8 to +5.5	+11.5 to +15.5	+4.5 to +5.5	V
Recommended control voltage adjustment range	+1.6 to +2.0 (Max. 2.1)	+0.5 to +1.8 (Max. 1.9)	+0.5 to +1.45 (Max. 1.5)	V
Settling time	10 <sup>①</sup>	10 <sup>②</sup>		s
Operating ambient temperature	+5 to +50			°C

① The time required for the output to reach a stable level following a change in the control voltage from +2.0 V to +1.6 V

② The time required for the output to reach a stable level following a change in the control voltage from +1.0 V to +0.5 V

## Specifications of individual products

### ● H14447

(at +25 °C)



Parameter	H14447	Unit
Spectral response	300 to 650	nm
Gain <sup>①</sup>	Typ. 8.4 × 10 <sup>9</sup>	—
Rise time	Typ. 0.35	ns
Maximum average output signal current	100	μA
Dark current <sup>①</sup>	Typ. 0.1	nA

① Control voltage: +2.0 V

### ● H11411

(at +25 °C)



Parameter	H11411	Unit
Spectral response	300 to 650	nm
Gain <sup>①</sup>	Typ. 3.3 × 10 <sup>6</sup>	—
Maximum average output signal current	200	μA
Dark current <sup>①</sup>	Typ. 6	nA

① Control voltage: +1.75 V

### ● H11432 / H11432-100

(at +25 °C)



Parameter	H11432 / H11432-100	Unit
Spectral response	300 to 650	nm
Gain <sup>①</sup>	Typ. 5.0 × 10 <sup>5</sup>	—
Maximum average output signal current	100	μA
Dark current <sup>①</sup>	Typ. 10	nA

① Control voltage: +1.3 V

## Spectral response

### ● H14447

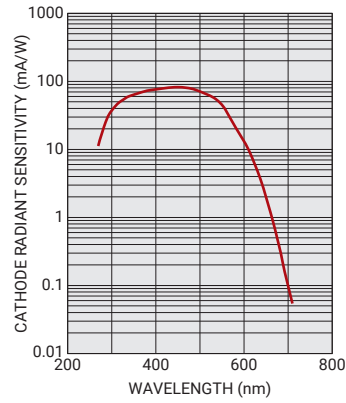

### ● H11411

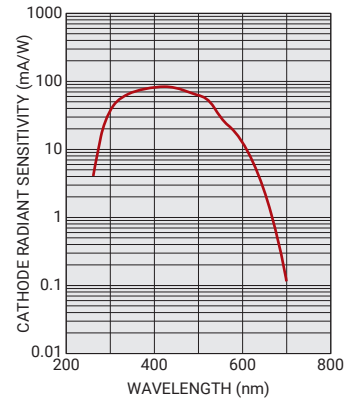

### ● H11432 series

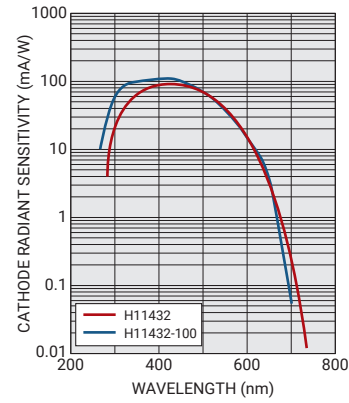

## Dimensional outline (Unit: mm)

### ● H14447

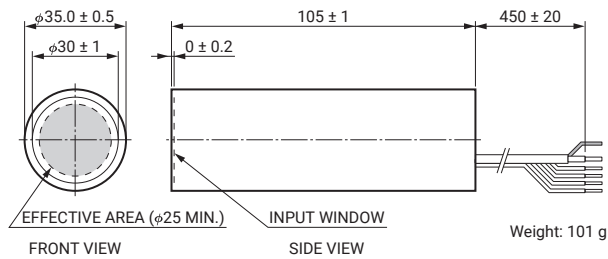

### ● H11411

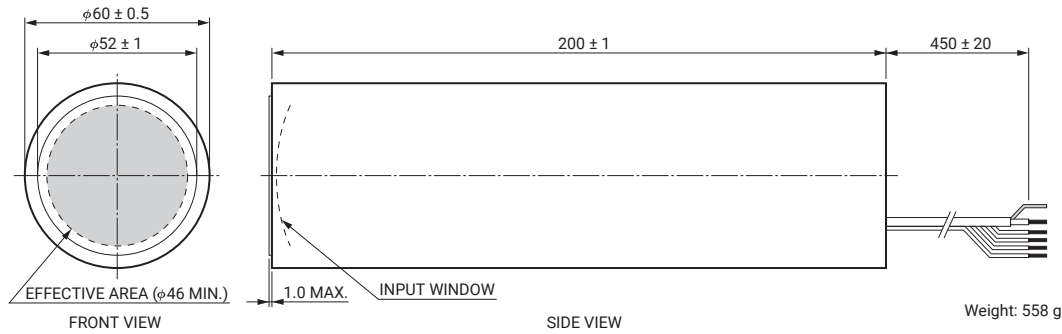

### ● H11432/H11432-100

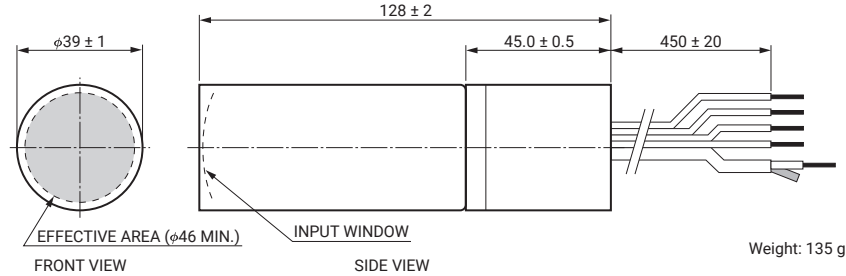

## ■ Signal input/output table

Signal type	H14447	H11411	H11432
		Cable	Cable
Low voltage input (+)	Red <sup>Ⓐ*1</sup>	Red <sup>Ⓐ*2</sup>	Red <sup>Ⓐ*1</sup>
GND		Black <sup>Ⓐ</sup>	
Vref output *3		Blue <sup>Ⓐ</sup>	
Vcont input *5	White <sup>Ⓐ*4</sup>	White <sup>Ⓐ*5</sup>	White <sup>Ⓐ*6</sup>
Signal output / Signal GND		Coaxial <sup>Ⓑ</sup>	

\*1: +5 V  
\*2: +15 V  
\*3: +2.5 V

\*4: +1.6 V to +2.0 V  
\*5: +0.5 V to +1.8 V  
\*6: +0.5 V to +1.45 V

Ⓐ UL1430 AWG26  
Ⓑ RG-174/U

# Photomultiplier tube modules for use in vacuum and reduced pressure environments

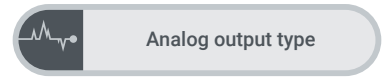

Analog output type

Photomultiplier tube modules H13229 • H14211 series



## Specifications of individual products

### • H13229 series

(at +25 °C)



Parameter	-110 / P-110	-210 / P-210	-01 / P-01	-20	Unit
Output	Current output				—
Output type	Pin				—
Spectral response	300 to 700		300 to 870	300 to 920	nm
Effective area	φ8				mm
Input voltage	+2.8 to +5.5 (Max. 5.5)				V
Recommended control voltage adjustment range	+0.5 to +1.1				V
Anode radiant sensitivity <sup>①</sup> Typ.	2.2 × 10 <sup>5</sup>	2.6 × 10 <sup>5</sup>	1.5 × 10 <sup>5</sup>		A/W
Maximum average output signal current <sup>①</sup>	100				μA
Dark current <sup>①</sup> Typ.	1			10	nA
Settling time <sup>①</sup>	10				s
Working pressure	Atmospheric pressure to 0.01 Pa				—
Operating ambient temperature	+5 to +50				°C

① Control voltage: +1.0 V

② The time required for the output to reach a stable level following a change in the control voltage from +1.0 V to +0.5 V

### • H14211 series

(at +25 °C)



Parameter	-110 / P-110	-210 / P-210	-01 / P-01	-20	-04 / P-04	-113 / P-113	Unit
Output	Current output						—
Output type	Cable						—
Spectral response	230 to 700	230 to 870	230 to 920	185 to 870	185 to 700		nm
Effective area	φ8						mm
Input voltage	+2.8 to +5.0 (Max. 5.5)						V
Recommended control voltage adjustment range	+0.5 to +1.1						V
Anode radiant sensitivity <sup>①</sup> Typ.	2.2 × 10 <sup>5</sup>	2.6 × 10 <sup>5</sup>	1.5 × 10 <sup>5</sup>		2.2 × 10 <sup>5</sup>		A/W
Maximum average output signal current <sup>①</sup>	100						μA
Dark current <sup>①</sup> Typ.	1		10	1			nA
Settling time <sup>②</sup> Max.	10						s
Working pressure	Atmospheric pressure to 0.001 Pa						—
Operating ambient temperature	+5 to +50						°C

① Control voltage: +1.0 V

② The time required for the output to reach a stable level following a change in the control voltage from +1.0 V to +0.5 V



## Spectral response

### ● H13229 series

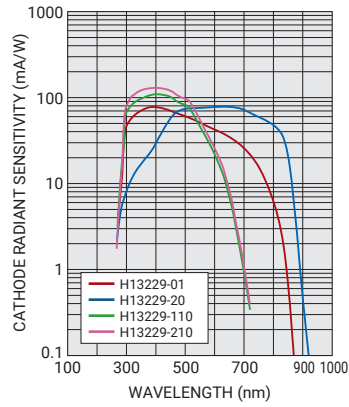

### ● H14211 series

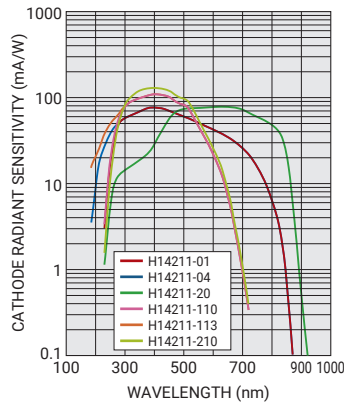

## Dimensional outline (Unit: mm)

### ● H13229 series

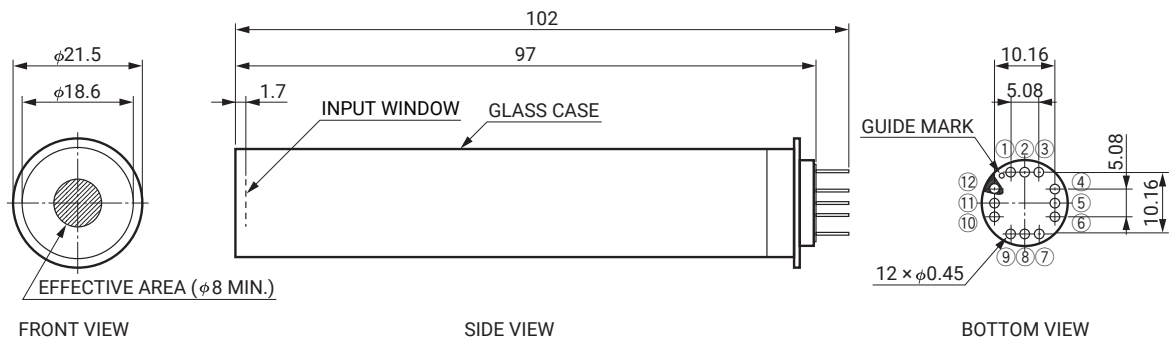

Weight: 37 g

### ● H14211 series

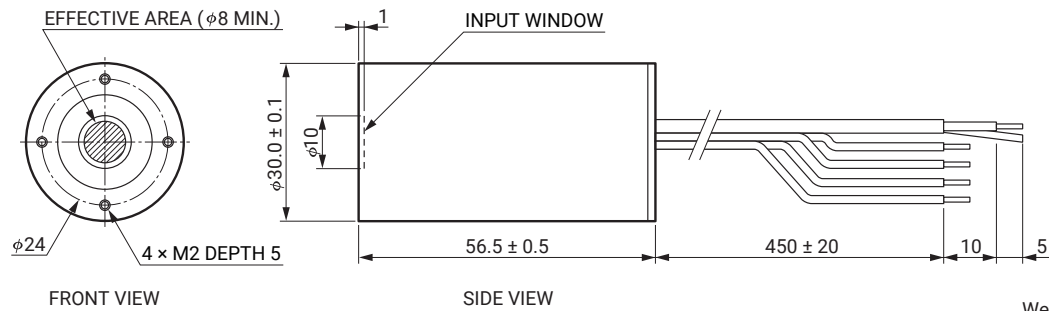

Weight: 74 g

## ■ Signal input/output table

Signal type	H13229	H14211
	Pin position	Cable
Low voltage input (+) *1	⑦	Red <sup>A</sup>
GND	⑫	Black <sup>A</sup>
Vref output *2	⑧	Blue <sup>A</sup>
Vcont input *3	①	White <sup>A</sup>
Signal output / Signal GND	⑩ / ⑨	Coaxial <sup>B</sup>
NC	②, ③, ④, ⑤, ⑥, ⑪	—

\*1: +5 V

\*2: +1.2 V

\*3: +0.5 V to +1.1 V

<sup>A</sup> AWG26

<sup>B</sup> RG-316/U

# Micro PMT and Metal package type photon counting heads

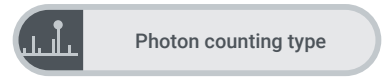

Photon counting heads H12406 • H10682 • H12386 • H11890 series



## Product line-up

(at +25 °C)

Parameter	H12406	H10682	H12386	H11890	Unit
PMT type	Micro PMT	Metal package PMT			—
Output type	Cable	Cable		USB Mini-B	—
Effective area	1(Y) × 3(X)	φ8			mm
Input voltage	+4.75 to +5.25	+4.75 to +5.25		USB Bus power	V
Count linearity	5.0 × 10 <sup>6</sup>	5.0 × 10 <sup>6</sup>		5.0 × 10 <sup>6</sup> (with function of linearity correction: 2.0×10 <sup>7</sup> )	s <sup>-1</sup>
Pulse-pair resolution	20	20			ns
Output pulse width	Typ. 10	10		—	ns
Output pulse Height	Min. +2.0 <sup>①</sup>	+2.0 <sup>①</sup> , +4.0 <sup>②</sup>		—	V
Recommended load resistance	50	50		—	Ω
Operating ambient temperature	+5 to +50	+5 to +40			°C

① Load resistance: 50 Ω    ② Un-terminated

## Specifications of individual products

### • H12406 series

(at +25 °C)



Parameter	H12406	H12406-01	H12406-20	Unit
Spectral response	300 to 650	300 to 850	300 to 920	nm
Dark count	Typ. 10	100	500	s <sup>-1</sup>

### • H10682 series

(at +25 °C)



Parameter	-110	-210	-01	Unit
Spectral response	230 to 700	230 to 700	230 to 870	nm
Dark count	Typ. 50	50	600	s <sup>-1</sup>

### • H12386 series

(at +25 °C)



Parameter	-110	-210	-01	Unit
Spectral response	230 to 700	230 to 700	230 to 870	nm
Dark count	Typ. 50	50	600	s <sup>-1</sup>

### • H11890 series

(at +25 °C)



Parameter	-110	-210	-01	Unit
Spectral response	230 to 700	230 to 700	230 to 870	nm
Dark count	Typ. 50	50	600	s <sup>-1</sup>
Counter gate time	1 to 10 000			ms
Interface <sup>①</sup>	USB2.0			—
Compatible OS <sup>②</sup>	Windows® 10 Pro			—

① Conform to in RS-232C    ② Sample program supplied

## Count sensitivity

### ● H12406 series

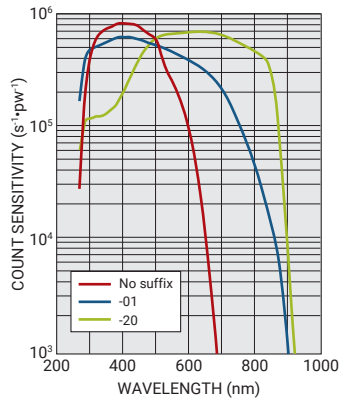

### ● H10682 / H12386 / H11890 series

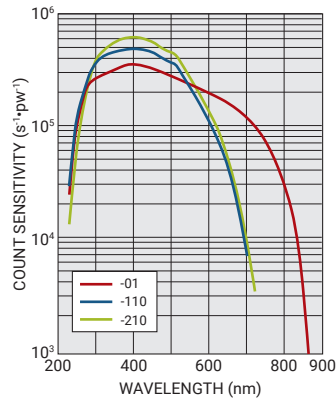

## Dimensional outline (Unit: mm)

### ● H12406 series

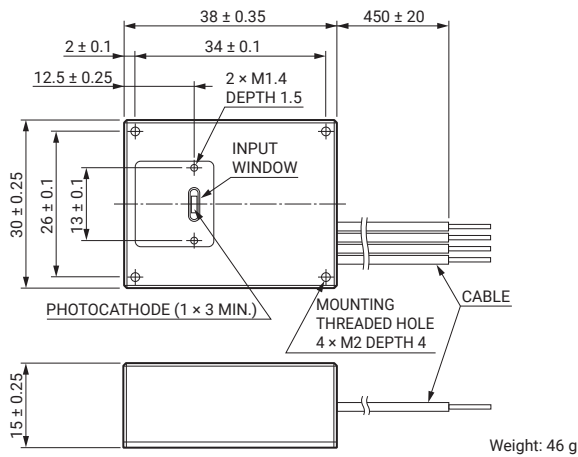

### ● H10682 series

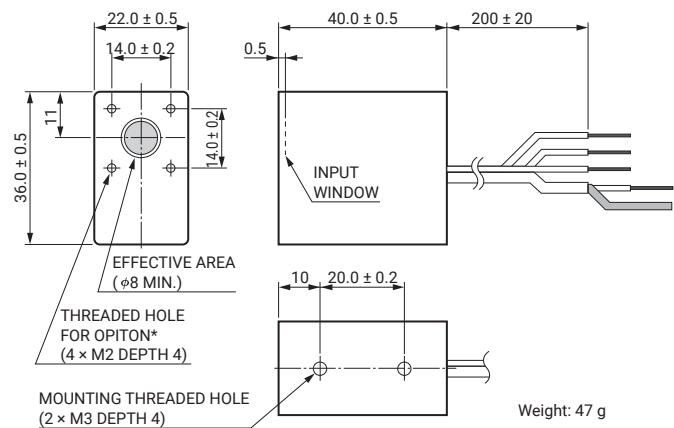

### ● H12386 series

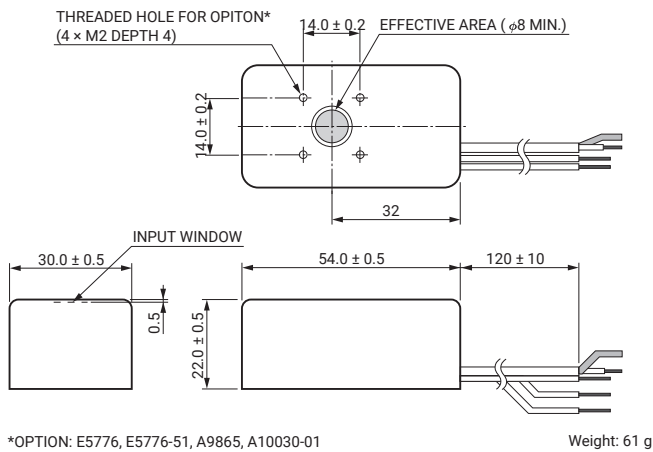

### ● H11890 series

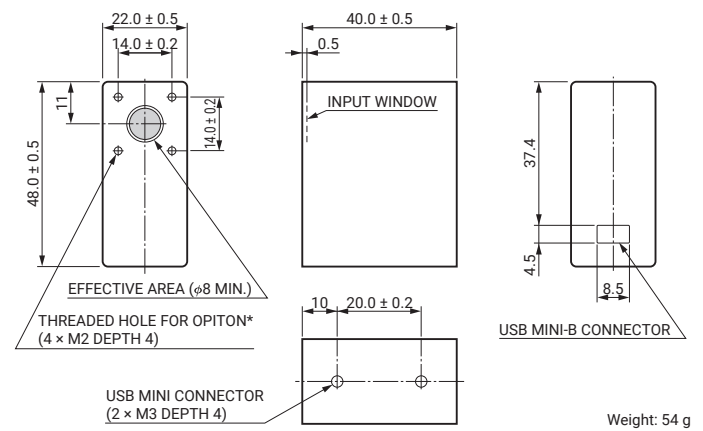

## ■ Signal input/output table

Signal type	H12406	H10682	H12386	H11890
	Cable	Cable	Cable	Cable
Low voltage input (+)	Red <sup>A*1</sup>	Red <sup>C*1</sup>	Red <sup>A*1</sup>	—
GND	Black <sup>A</sup>	Black <sup>C</sup>	Black <sup>A</sup>	—
Over light detection output	Blue <sup>A</sup>	Blue <sup>C</sup>	Blue <sup>A</sup>	—
Signal output / Signal GND	Coaxial <sup>B</sup>		Coaxial <sup>B</sup>	—

\*1: +5 V

<sup>A</sup> UL1430 AWG26  
<sup>B</sup> RG-174/U

<sup>C</sup> UL1430 AWG24  
<sup>D</sup> RG-178B/U

# Side-on type photon counting heads with gate function

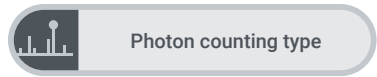

photon counting heads H8259 series

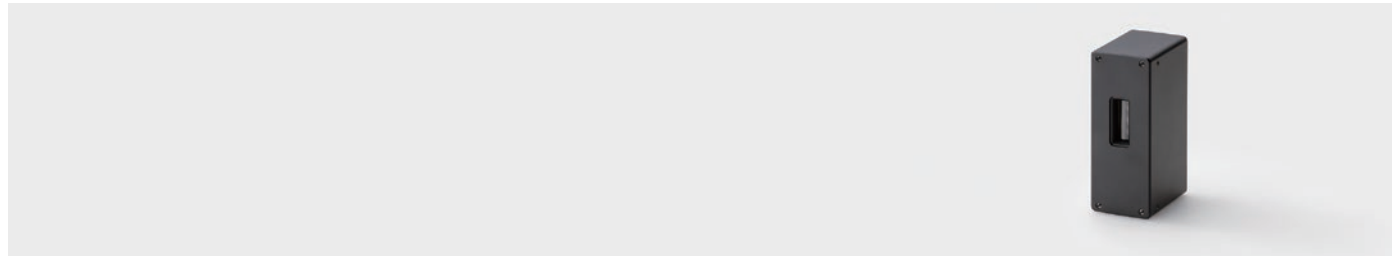

## Specification

(at +25 °C)

Parameter	H8259	H8259-01	H8259-02	Unit
Output	Photon counting			—
Output type	Cable with connector			—
Spectral response	185 to 680	185 to 850	185 to 900	nm
Effective area	4 × 20		4 × 6	mm
Input voltage	+4.5 to +5.5			V
Count linearity	2.5 × 10 <sup>6</sup>			s <sup>-1</sup>
Dark count	Typ. 30	80	400	s <sup>-1</sup>
Gate width (FWHM)	50 μs to DC <sup>①</sup>			—
Repetition rate	Max. 10	10	10	kHz
Pulse-pair resolution	35			ns
Output pulse width	30			ns
Output pulse Height	Min. +2.0 <sup>②</sup>	+2.0 <sup>②</sup>	+2.0 <sup>②</sup>	V
Recommended load resistance	50			Ω
Operating ambient temperature	+5 to +40			°C

- ① Normally ON
- ② Load resistance: 50 Ω

## Count sensitivity

● H8259 series

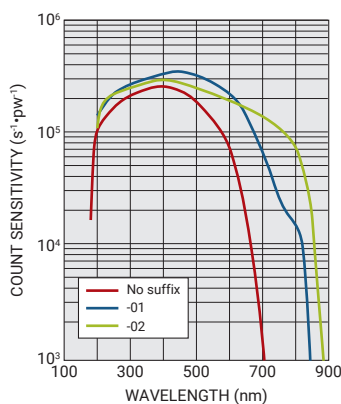

## Dimensional outline (Unit: mm)

● H8259 series

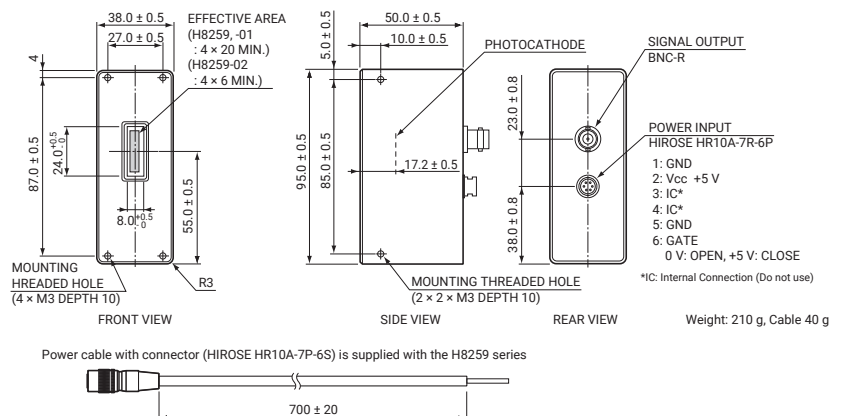

## Signal input/output table

Signal type	H8259	
	Cable	
Low voltage input *1	Red	Attached power cable (HIROSE HR10A-7R-6P)
GND	Black	Attached power cable (HIROSE HR10A-7R-6P)
Signal output / Signal GND	Coaxial BNC-R	
GATE SIGNAL INPUT	Green	Attached power cable (HIROSE HR10A-7R-6P)

\*1: +5 V

# Multi-channel photon counting head

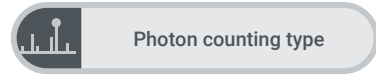

## Photon counting head H14870



### Specification

(at +25 °C)

Parameter	H14870	Unit
Output	Photon counting	—
Output type	Cable with connector	—
Spectral response	300 to 650	nm
Effective area / ch	φ5	mm
Input voltage	+4.75 to +5.25 (Max. 5.5)	V
Count linearity / ch	$3.0 \times 10^6$	$s^{-1}$
Dark count / ch	Typ. 50	$s^{-1}$
Pulse-pair resolution	33	ns
Output pulse width	Depends on PMT output signal	ns
Output pulse Height	Typ. LVDS offset voltage: 1.25, Differential voltage: 0.3 ①	V
Recommended load resistance	100	Ω
Operating ambient temperature	+5 to +40	°C

① Load resistance 100 Ω

### Count sensitivity

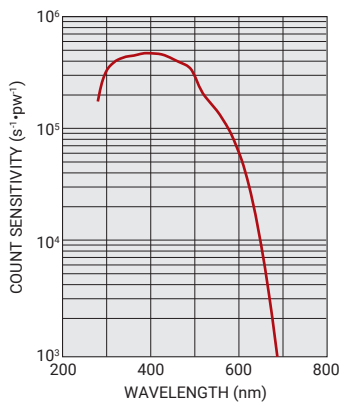

### Dimensional outline (Unit: mm)

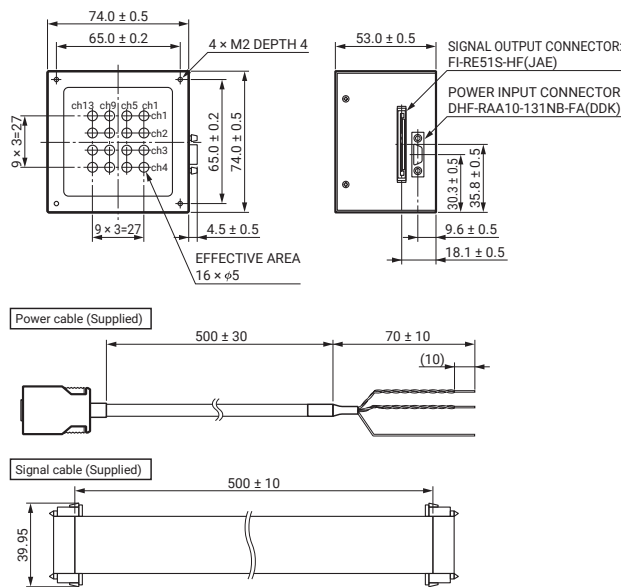

#### PIN ASSIGNMENT

SIGNAL OUTPUT CONNECTOR:  
FI-RE51S-HF(JAE)

No.	No.	No.	No.
1	GND	18	CH11-
2	GND	19	CH11+
3	CH16-	20	GND
4	CH16+	21	CH10-
5	GND	22	CH10+
6	CH15-	23	GND
7	CH15+	24	CH9-
8	GND	25	CH9+
9	CH14-	26	GND
10	CH14+	27	CH8-
11	GND	28	CH8+
12	CH13-	29	GND
13	CH13+	30	CH7-
14	GND	31	CH7+
15	CH12-	32	GND
16	CH12+	33	CH6-
17	GND	34	CH6+
		35	GND
		36	CH5-
		37	CH5+
		38	GND
		39	CH4-
		40	CH4+
		41	GND
		42	CH3-
		43	CH3+
		44	GND
		45	CH2-
		46	CH2+
		47	GND
		48	CH1-
		49	CH1+
		50	GND
		51	GND

POWER INPUT CONNECTOR:  
DHF-RAA10-131NB-FA(DDK)

No.	
1	Vcc (+5 V)
2	Vcc (+5 V)
3	GND
4	GND
5	NC
6	NC
7	IC (Internal Connection)
8	IC (Internal Connection)
9	IC (Internal Connection)
10	IC (Internal Connection)

### Signal input/output table

Signal type	H14870
	Cable
Low voltage input	Orange (+5 V)(UL20276 AWG28)
GND	Gray (UL20276 AWG28)
SHIELD	—

# Head-on type photon counting heads



Photon counting type

Photon counting heads H11870 • H13467 series, H11123

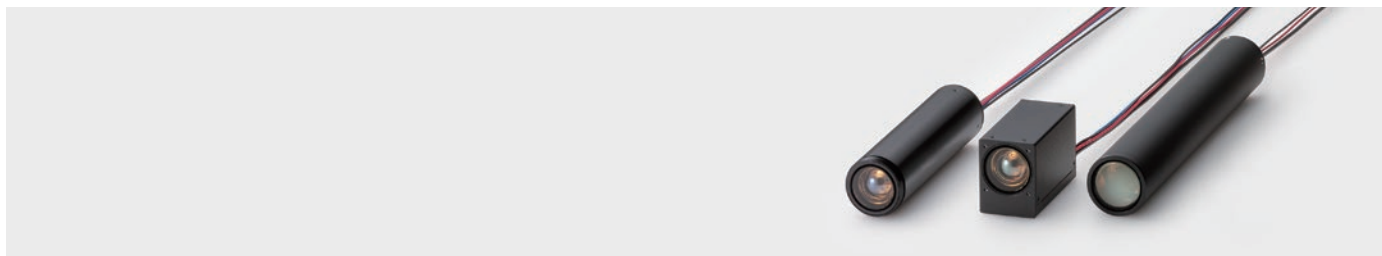

## Product line-up

(at +25 °C)

Parameter	H11870	H13467	H11123	Unit
Output	Photon counting			—
Output type	Cable			—
Input voltage	+4.75 to +5.25			V
Count linearity	$6.0 \times 10^6$		$5.0 \times 10^6$	$s^{-1}$
Pulse-pair resolution	18		20	ns
Output pulse width	9		10	ns
Output pulse Height	Min.	+2.0 <sup>①</sup> , +4.0 <sup>②</sup>		V
Recommended load resistance	50			$\Omega$
Operating ambient temperature	+5 to +40			°C

① Load resistance: 50  $\Omega$

② Un-terminated

## Specifications of individual products

### • H11870 series

(at +25 °C)



Parameter	H11870-01	H11870-02	H11870-03	H11870-09	Unit
Spectral response	300 to 650	300 to 650	300 to 850	185 to 320	nm
Effective area	$\phi 22$			$\phi 21$	mm
Dark count	Typ. 15	60	5000	15	$s^{-1}$

### • H13467 series

(at +25 °C)



Parameter	H13467-01	H13467-02	H13467-03	Unit
Spectral response	300 to 650	300 to 650	300 to 850	nm
Effective area	$\phi 22$			mm
Dark count	Typ. 15	60	5000	$s^{-1}$

### • H11123

(at +25 °C)



Parameter	H11123	Unit
Spectral response	300 to 650	nm
Effective area	$\phi 25$	mm
Dark count	Typ. 100	$s^{-1}$



## Count sensitivity

● H11870-01/-02/-03 • H13467 series

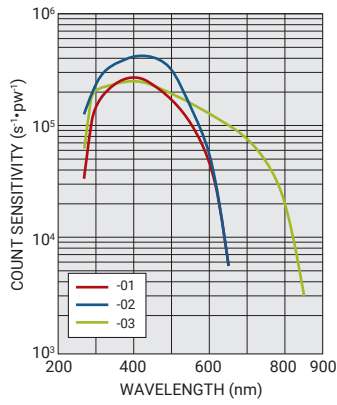

● H11870-09

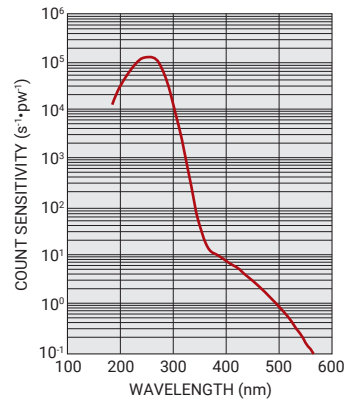

● H11123

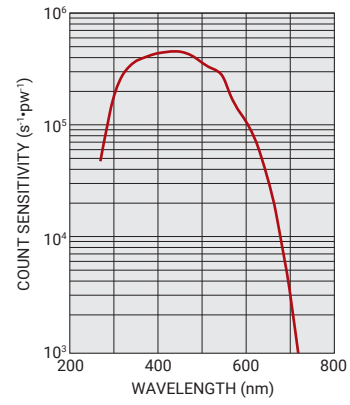

## Dimensional outline (Unit: mm)

● H11870 series

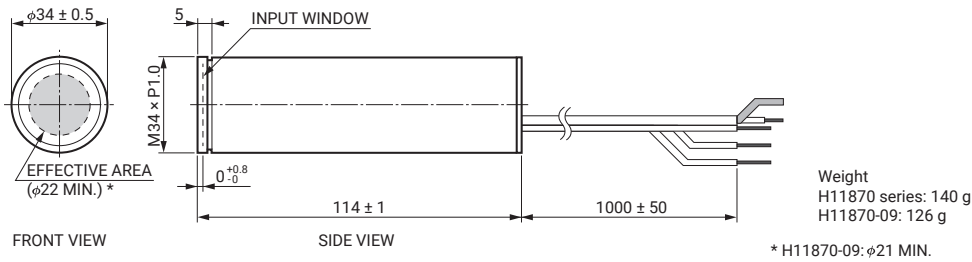

● H13467 series

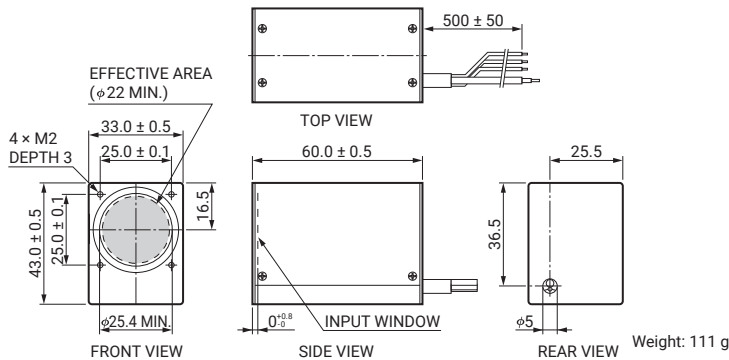

● H11123

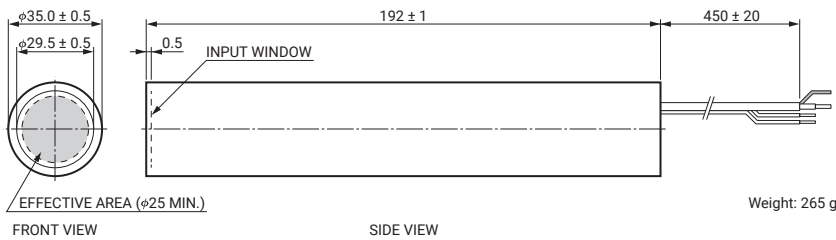

## Signal input/output table

Signal type	H11870	H13467	H11123
	Cable	Cable	Cable
Low voltage input (+) *1		Red <sup>(A)</sup>	
GND		Black <sup>(A)</sup>	
Over light detection output		Blue <sup>(A)</sup>	—
Signal output / Signal GND		Coaxial <sup>(B)</sup>	

\*1: +5 V

<sup>(A)</sup> UL1430 AWG24

<sup>(B)</sup> RG-174/U

# Head on type photon counting heads

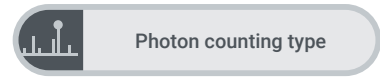

Photon counting heads H12775, H7828 • H9319 series



## Product line-up

(at +25 °C)

Parameter	H12775	H7828	H9319	Unit
Output	Photon counting			—
Output type	Cable			—
Input voltage	+4.75 to +5.25	+4.5 to +5.5	+4.75 to +5.25	V
Count linearity	$5.0 \times 10^6$	$1.5 \times 10^6$	$20 \times 10^6$	s <sup>-1</sup>
Pulse-pair resolution	20	70	—	ns
Output pulse width	10	30	—	ns
Output pulse Height	Min. +2.0 <sup>①</sup> , +4.0 <sup>②</sup>	+3.0 <sup>①</sup>	—	V
Recommended load resistance	50			Ω
Operating ambient temperature	+5 to +40		+5 to +50	°C

① Load resistance: 50 Ω

② Un-terminated

## Specifications of individual products

### • H12775

(at +25 °C)



Parameter	H12775	Unit
Spectral response	300 to 650	nm
Effective area	φ10	mm
Dark count	Typ. 30	s <sup>-1</sup>

### • H7828 series

(at +25 °C)



Parameter	H7828	H7828-01	Unit
Spectral response	300 to 650	300 to 850	nm
Effective area	φ15		mm
Dark count	Typ. 200	2000	s <sup>-1</sup>

### • H9319 series

(at +25 °C)

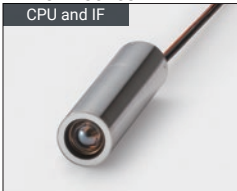

Parameter	H9319-01	H9319-11	H9319-02	H9319-12	Unit
Spectral response	300 to 650		300 to 850		nm
Effective area	φ22				mm
Dark count	Typ. 150	10000			s <sup>-1</sup>
Counter gate time	10 to 1000				ms
Input signal (External trigger input)	TTL level signal				—
Output signal (User line output)	TTL level signal				—
Interface	RS-232C				—
Sample program	Yes	No	Yes	No	—

## Count sensitivity

### ● H12775

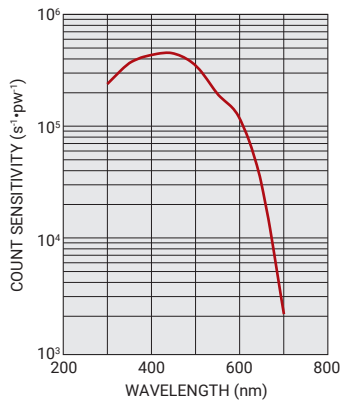

### ● H7828 series

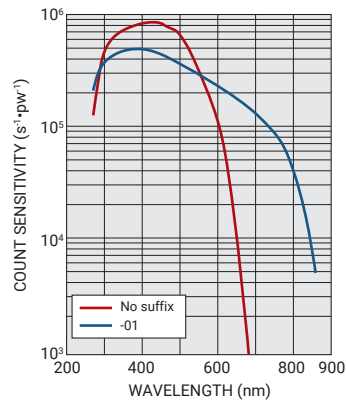

### ● H9319 series

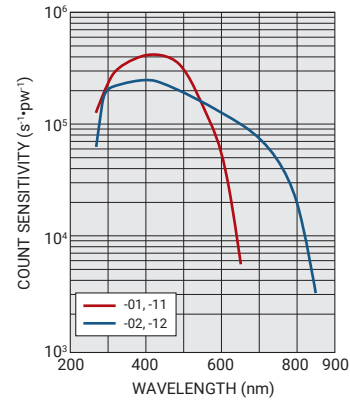

## Dimensional outline (Unit: mm)

### ● H12775

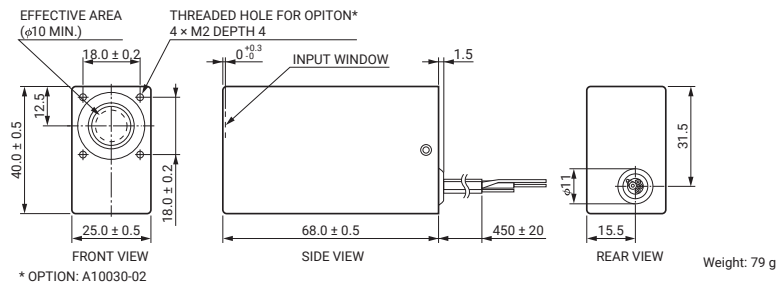

### ● H7828 series

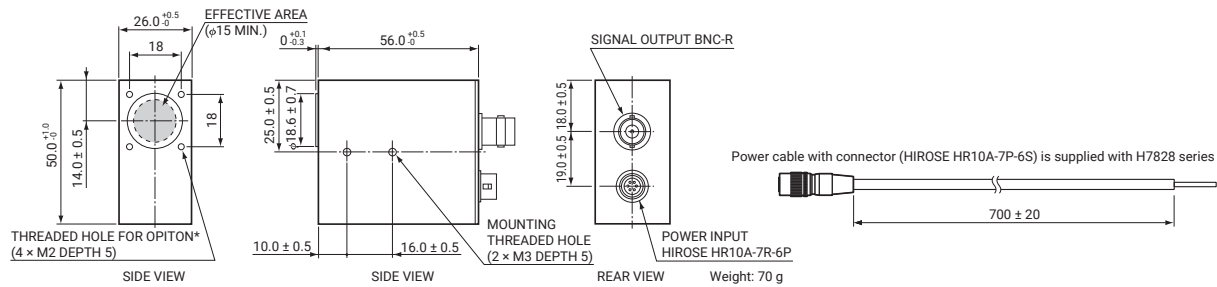

### ● H9319 series

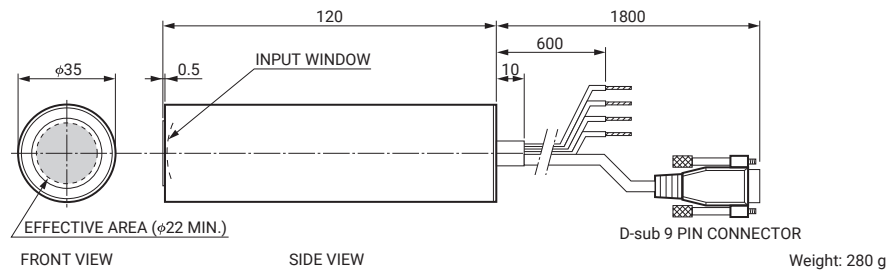

## ■ Signal input/output table

Signal type	H12775	H7828	H9319
	Cable	Cable	Cable
Low voltage input (+) *1	Red <sup>(A)</sup>	Red <sup>(C)</sup>	Yellow
GND	Black <sup>(A)</sup>	Black <sup>(C)</sup>	Black
Over light detection output	Blue <sup>(A)</sup>	—	—
Signal output / Signal GND	Coaxial <sup>(B)*2</sup>	Coaxial <sup>(D)</sup>	—
User line (TTL output)	—	—	Orange
External trigger (TTL input)	—	—	Purple

\*1: +5 V

\*2: BNC connector is selectable as an option.

(A) UL1430 AWG26

(B) RG-174/U

(C) Attached power cable (HIROSE HR10A-7R-6S)

(D) BNC-R

# Related products

## Power supplies for PMT modules C7169, C10709



The C7169 and C10709 are power supply units for photomultiplier tube modules. Input voltage and control voltage for photomultiplier tube modules can be supplied by this power supply unit alone.

(at +25 °C)

Parameter	C7169	C10709	Unit
Output voltage	±15	±5	V
Output current	Max. 0.3 (+15 V), 0.2 (-15 V)	2.0 (+5 V), 0.2 (-5 V)	A
Control voltage <sup>①</sup> (variable voltage range)	+0.25 to +1.8		V
Output connector	Binding post		—
Input voltage	100 to 240 (50 Hz/60 Hz)		V

<sup>①</sup> Adjust within the recommended control voltage range for the photomultiplier tube module being used.

## Amplifier units, Amplifier modules



These are amplifier units and amplifier modules for photomultiplier tubes and current output type PMT modules. Output signal from photomultiplier tubes can be directly input into these amplifiers.

### ● Frequency bandwidth 100 MHz or less

Parameter	C7319	C12419	C9999	C9999-01	C6438	C6438-01	C6438-02	M7279	Unit
Frequency bandwidth (+3 dB)	DC to 20 kHz DC to 200 kHz (Switchable) <sup>①</sup>	DC to 1 MHz	DC to 10 MHz		DC to 50 MHz			DC to 10 MHz	—
Signal connector	BNC-R							On-board mounting	—
Current-to-voltage conversion factor	0.1 V/μA, 1 V/μA, 10 V/μA (Switchable) <sup>①</sup>	1 V/μA	50 mV/μA	10 mV/μA	0.5 mV/μA	25 mV/μA	5 mV/μA	10 mV/μA	—
Signal input polarity	Positive / Negative								—
Signal output polarity	Inverting	Inverting	Non-inverting	Switchable	Non-inverting	Non-inverting	Switchable	Non-inverting	—
Supply voltage	±5 to ±15	±15	±5		±5			±5 to ±6.5	V

<sup>①</sup> Frequency bandwidth is limited to DC to 100 kHz at conversion ratio of 10 V/μA.

### ● Frequency bandwidth 100 MHz or higher

Parameter	C9663	C11184	C5594-12	C5594-22	C5594-44	M8879	Unit
Frequency bandwidth (+3 dB)	DC to 150 MHz	DC to 300 MHz	50 kHz to 1.5 GHz			DC to 150 MHz	—
Signal connector	BNC-R	MCX-R (MCX-BNC adapter is supplied)	Input: SMA-P Output: SMA-R	SMA-R	BNC-R	On-board mounting	—
Current-to-voltage conversion factor	4 mV/μA	1.25 mV/μA	3.15 mV/μA			4 mV/μA	—
Signal input polarity	Positive / Negative						—
Signal output polarity	Non-inverting						—
Supply voltage	±5	±5	+12 to +16			±5 to ±6	V

## Related products

### Photon counting unit C9744



The photon counting unit C9744 converts single photoelectron pulses from a photomultiplier tube into digital signals of logic pulse by use of the built-in amplifier and discriminator circuits.

Photon counting can be easily performed by simply connecting a counter to the output of the photon counting unit. The C9744, which incorporates a prescaler (division by 10), can perform measurement with an excellent output linearity up to  $10^7 \text{ s}^{-1}$ .

(at +25 °C)

Parameter	C9744		Unit
Input impedance	50		$\Omega$
Discrimination level (input conversion)	-0.4 to -16		mV
Required PMT gain	$3 \times 10^6$		—
Prescaler <sup>①</sup>	$\div 1$	$\div 10$	—
Count linearity <sup>②</sup>	$4 \times 10^6$	$1 \times 10^7$	$\text{s}^{-1}$
Pulse-pair resolution <sup>②</sup>	25	10	ns
Output pulse width <sup>②</sup>	10	Depends on count rate	
Output pulse	CMOS, positive logic		—
Connector	BNC-R		—
Power supply connector	DIN-R (6 pin) <sup>③</sup>		—
Supply voltage	$+5.0 \text{ V} \pm 0.2 \text{ V}, 130 \text{ mA} / -5.0 \text{ V} \pm 0.2 \text{ V}, 50 \text{ mA}$		—

<sup>①</sup> Setting can be selectable by switch.

<sup>②</sup> Varies depending on prescaler setting.

<sup>③</sup> Supplied with a cable (1.5 m) attached to the mating plug.

### Counting unit C8855-01



The C8855-01 is a counting unit with a USB interface port. The counter of the C8855-01 has two counter circuits (double counter method) capable of counting input signals with no dead time. The sample software that comes with the C8855-01 helps you to start measurement easily and quickly.

(at +25 °C)

Parameter	C8855-01	Unit
Number of input signals	1	ch
Signal input level	CMOS positive logic	—
Signal pulse width	8 or longer	ns
Input impedance	50	$\Omega$
Max. count rate	50	MHz
Internal counter gate time	50 $\mu\text{s}$ to 10 s (1, 2, 5 Step)	—
Trigger method	Software / External trigger	—
External trigger signal	TTL negative logic	—
OS	Windows® 8.1/10 Pro	—
Interface	USB (Type B)	—
Supply voltage	$+7 \text{ V} / 1.6 \text{ A}$ (AC adapter included)	—

# Related products

## Optical blocks for PMT module



Optical blocks are precision units that contain or can contain optical components such as bandpass filters and dichroic mirrors. These blocks are specially designed for low-light-level measurements using PMT modules. Their optical components are precisely arranged to ensure complete light shielding. They can be easily attached/detached by thumbscrews allowing optical blocks to be freely combined as needed. Optical blocks can be assembled in combination with light sources such as lasers or microscope objective lenses to create confocal optical systems or fluorescence microscopes.

● C-mount adapter A9865



This adapter connects a PMT module to C-mount threaded optical blocks. This adapter can also be connected to a device with C-mount.

● Fiber adapter block A10037 series



This block connects to optical fibers with a FC/SMA connector. The lens assembled in the block collimates the light spreading from the optical fiber.

● C-mount adapter block A10039



This block connects a device having C-mount to V-groove type optical blocks. The connection angle for the device and block is adjustable.

● C-mount interchangeable filter block A11213 series



This is a C-mount connection block for installing a commercially available 25 mm diameter filter or lens. This block allows angle adjustment and so is useful as a spacer or adapter that connects between C-mounts.

● Adapter block



This is an adapter block for connecting a PMT module to a V-groove type optical block.

● Filter block A10033-90



This is a holder block for assembling a commercially available 15 mm diameter filter.

● Pinhole block A11027



This is a holder block that can hold a commercially available, mount type pinhole. Light passing through the pinhole is collimated by the lens installed in the block and is output.

● C-mount interchangeable dichroic block A11214



This is a C-mount connection block for installing a commercially available dichroic mirror having a 45 degree incident angle, 1 mm thickness, and dimensions of 26 × 38 mm.

\* Other types of optical blocks are also available besides the products listed here. For more details please refer to the individual catalogs or access our web site.

## Connection example

● Single wavelength detection with C mount

Optical filter within the block passes only light at a specific wavelength which is then detected by the PMT module.

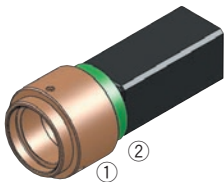

Optical blocks	Type No.	No.
C-mount interchangeable filter block	A11213-xx	①
C-mount adapter	A9865	②

● Fiber-optic single wavelength detection

Light emitted and spreading from an optical fiber cable is collimated by the lens within the A10037 series fiber adapter block and so is effectively guided to the PMT module.

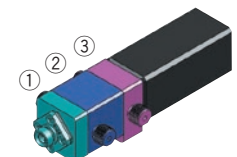

Optical blocks	Type No.	No.
Filter block	A10037-xx	①
Filter block	A10033-90	②
Adapter block	A10030-xx	③

● Fiber-optic dual wavelength detection

The dichroic mirror within the block reflects light shorter than a certain wavelength and passes light longer than that wavelength. The optical filters further pass only light at a specific wavelength which is then detected by PMT modules.

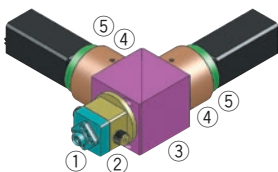

Optical blocks	Type No.	No.
Fiber adapter block	A10037-xx	①
C-mount adapter block	A10039	②
C-mount interchangeable dichroic block	A11214	③
C-mount interchangeable filter block	A11213	④
C-mount adapter	A9865	⑤

● Extended example of microscope

Connecting the A11027 pinhole block to the C-mount port of a microscope configures a confocal optical system. Light passing through the pinhole is collimated by the lens in the block and is efficiently guided to the PMT module.

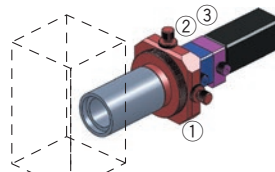

Optical blocks	Type No.	No.
Pinhole block	A11027	①
Filter block	A10033-90	②
Adapter block	A10030-xx	③



# Related products

## Stabilized light sources L11416, L11494 series

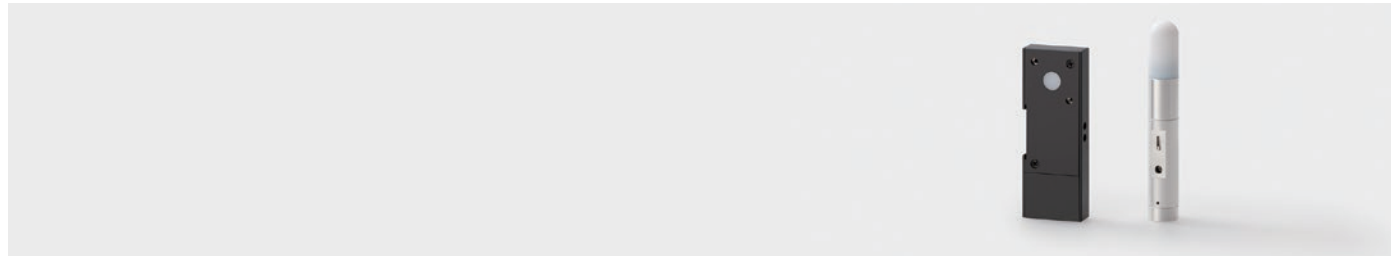

The L11416 and L11494 series are LED light sources mainly designed for adjusting the sensitivity of PMT (photomultiplier tubes) and PMT modules. The L11416 series is a test tube type easily mounted in lab devices such as for blood sampling, while the L11494 series is a plate type designed to be placed on a sample stage.

Stable continuous light of approximately 1 pW is always output because the LED emission power is controlled by monitoring with a photodiode. (at +25 °C)

Parameter	L11416-470	L11416-525	L11416-555	L11416-590	L11494-430	L11494-470	L11494-525	L11494-660	Unit
Peak emission wavelength	465	522	555	592	428	465	522	660	nm
Spectral half width	26	35	30	18	65	26	35	30	nm
Light emission power	$1 \pm 0.5$ ①				High: $1 \pm 0.5$ , Low: $0.01 \pm 0.005$ ②				pW
Emission area	—				$\phi 7.0$				mm
Emission stability (0 °C to +50 °C)	$\pm 2$ Max.								
Battery	Button battery SR41 or equivalent								
Battery service life	Min.	24			10	24			h
Operating ambient temperature					0 to +50				°C
Operating ambient humidity ③					85 below				%
Storage temperature					-20 to +60				°C
Storage humidity ③					85 below				%
Weight	13				23				g

① Adjusted by using a 22 mm effective diameter photon counting head placed at a position 5 mm away from the L11416.

② Adjusted by using an 8 mm effective diameter photon counting head placed in direct contact with the L11494. ③ No condensation

### Usage example

#### ● L11416

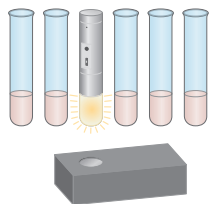

#### ● L11494

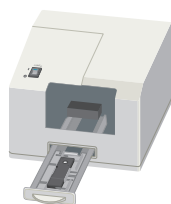

### Optical fiber adapters for PMT modules E5776, E5776-51

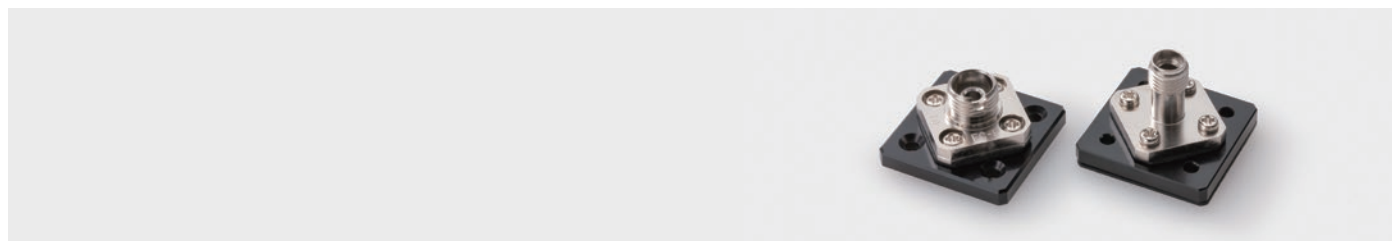

This optical fiber adapter allows connection to an optical fiber cable which has FC or SMA connector. Light from an optical fiber can be easily guided into a PMT module by installing this adapter to the light input side of the PMT module.

#### ● FC type E5776

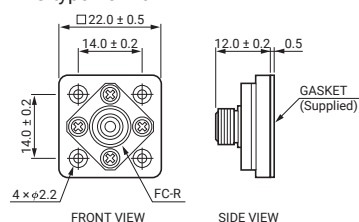

#### ● SMA type E5776-51

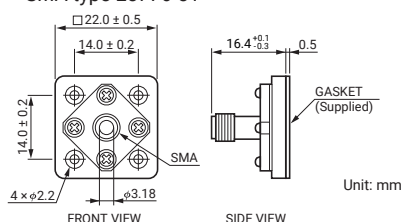

Unit: mm

\* Four M2 screws are supplied for installing to a PMT module.

\* When placing a bandpass filter between an optical fiber and PMT module, we recommend using the A10037 series fiber adapter block (P. 40) that contains a lens for collimating light spreading from the optical fiber.

\* Compatible PMT modules are the same as those for optical blocks. See page 1 for details.

# Technical guide

## General characteristics

### • Photocathode radiant sensitivity and quantum efficiency

Radiant sensitivity is the photoelectric current generated from the photocathode when struck by light at a given wavelength, divided by the radiant flux of the incident light, and expressed in A/W (amperes per watt). Quantum efficiency (QE) is the number of photoelectrons emitted from the photocathode divided by the number of incident photons and is usually expressed as a percent (%). Cathode radiant sensitivity is one factor in determining signal-to-noise (S/N) characteristics and detection limit of measurement systems, and is used to calculate signal-to-noise ratio (S/N ratio) and noise equivalent power (NEP) representing a lower detection limit. We attach spectral response data showing radiant sensitivity to individual photomultiplier tubes only when requested by the customer and we charge for this service. If spectral response data is necessary, please request it before placing an order since the measurement takes a lot of time.

### • Luminous sensitivity

Cathode luminous sensitivity is the photoelectric current generated from the photocathode when a photomultiplier tube receives light flux from a tungsten filament lamp operated at a distribution temperature of 2856 K. Anode luminous sensitivity is the anode output current per incident light flux on the photocathode of a photomultiplier tube when a specific high voltage is supplied. The light flux is lowered to an appropriate level by using a neutral density filter, etc. Luminous sensitivity data is measured and listed in the test sheet prior to shipment (except for some types of products). Luminous sensitivity is useful when comparing the sensitivity of photomultiplier tubes having a similar spectral response range.

### • Blue sensitivity index and red/white ratio

Although different from absolute spectral response characteristics, the blue sensitivity index and the red/white ratio are often used for simple comparison of blue sensitivity and red sensitivity. Blue sensitivity index is the photoelectric current generated from the photocathode when a blue filter is interposed in the same measurement system as used to measure cathode luminous sensitivity. Blue sensitivity index is an essential parameter in scintillation counting because NaI(Tl) scintillators frequently used in scintillation counting produce light emissions close to the blue spectrum when transmitted through a blue filter. Blue sensitivity index is not represented in lumens because the light flux once transmitted through a blue filter cannot be expressed in lumens. Red/white ratio is used for comparing the sensitivity of photomultiplier tubes having a spectral response extending to the near infrared region. Like blue sensitivity index, the red/white ratio is also measured with the measurement system used for cathode luminous sensitivity, but a red to infrared filter is interposed. Red/white ratio is defined as the ratio of the cathode sensitivity measured with a red to infrared filter relative to the cathode luminous sensitivity when measured without a filter.

### • Gain

Gain of photomultiplier tubes listed in this catalog is the anode output current divided by the cathode output current, which is obtained when at a specified control voltage is input. A high voltage corresponding to the control voltage is input to a photomultiplier tube, so the higher the control voltage, the higher the gain will be.

### • Dark current

A small amount of output current appears from a PMT module even when operated in a completely darkness. This output current is called "dark current." Dark current varies with the control voltage, which is in nearly proportion to the change in gain. However, the slope of the dark current versus the voltage curve becomes less steep as the control voltage is decreased. This dark current at a low control voltage is mainly comprised of leakage current generated on the glass stem and lead pins of the photomultiplier tube or the surface of the circuit boards. Most of dark current originates from thermionic emissions from the photocathode. Cooling PMT modules

is therefore very effective in reducing the dark current, but PMT modules should always be used within the specified operating ambient temperature range. PMT modules with a cooler are designed to cool the built-in photomultiplier tube very efficiently, reducing the dark current in a short time.

### • Spatial uniformity

When a light spot strikes a small area on a photocathode, the output value may vary depending on the position of light incident on the photocathode. This variation in the output value is called "spatial uniformity." Spatial uniformity is mainly caused by the irregular sensitivity of the photocathode itself and also by a non-uniform loss of electrons due to differences in the electron trajectories. Spatial uniformity also depends on the wavelength of light. In general, if spatial uniformity affects measurements, the input light should be made to illuminate a wider area on the photocathode, or a diffuser plate should be placed in front of the photocathode.

### • Temperature characteristics

Sensitivity and dark current (dark count) of photomultiplier tubes change with the ambient temperature. The rate of this change (temperature coefficient) depends on the wavelength of light. As the ambient temperature decreases, sensitivity increases in the ultraviolet to visible region while it tends to decrease in the longer wavelength region. As temperature decreases, dark current (dark count) also decreases because the thermionic emission of electrons is reduced.

### • Drift and life characteristics

While operating a photomultiplier tube continuously over a long period of time, the anode output current may vary slightly over time, even though the operating conditions have been kept constant. In this kind of anode current behavior, the stability over a short operating time is called the drift characteristic, while the stability over an extended period of time is called the life characteristics. Both drift and life characteristics differ according to the type of photomultiplier tubes and the magnitude of anode current drawn from the photomultiplier tube. When stability is important in measurements, operating the photomultiplier tube at an average anode current of 1  $\mu$ A or less is recommended.

### • Time response characteristics

Time response characteristics of photomultiplier tubes are very important when measuring high-speed signals. Time response characteristics are usually evaluated in terms of electron transit time, rise time and electron transit time spread (TTS). These time response characteristics differ depending on the type of photomultiplier tube contained in PMT modules. In the case of current-output PMT modules, in addition to the time response characteristics of the built-in photomultiplier tube itself, the signal load conditions have effects on the PMT module response speed. When the load resistance to current-output PMT modules is made larger, the signal voltage increases but the response speed reduces.

### • Signal-to-noise characteristics

When observing the output of a photomultiplier tube, fluctuations (AC components) can be seen in the signal components. This is so-called "shot noise" resulting from statistical fluctuations in the photoelectron emission and electron multiplication processes. In low-light-level measurement, dark current can be subtracted, so shot noise is the dominant factor in determining the signal-to-noise ratio (S/N ratio). To minimize the shot noise and obtain a better S/N ratio, note the following points.

1. Use a PMT module with a high quantum efficiency in the wavelength range to be measured.
2. Design the optical system for better light collection efficiency so that light is incident on the PMT module with a minimum loss.
3. Narrow the measuring system bandwidth as much as possible.

## Sensitivity adjustment method

- Adjust the sensitivity by adjusting the control voltage.
- The reference voltage should be electrically isolated.
- When adjusting the sensitivity using a variable resistor, monitor the control voltage so that it does not exceed the maximum value.

### • Current output type

#### • Voltage programming

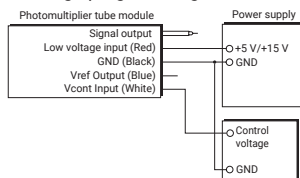

#### • Resistance programming

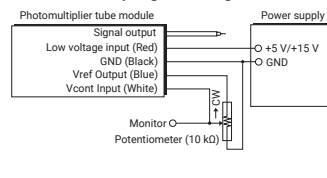

### • Voltage output type

#### • Voltage programming

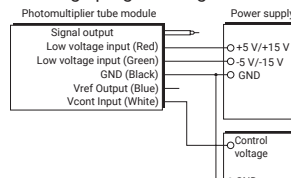

#### • Resistance programming

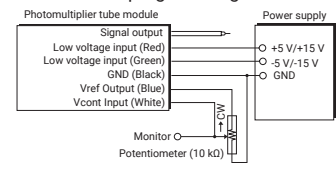

## Power supply circuit characteristics

### ● Power supply circuit

There are mainly two types of power supply circuits used in Hamamatsu PMT modules. One type is the Cockcroft-Walton circuit. The other is an active type divider circuit combined with the Cockcroft-Walton circuit.

### ● Cockcroft-Walton circuit

The Cockcroft-Walton circuit is a voltage booster circuit with an array of series-connected diodes, and with capacitors connected at each of the alternate connection points. When a reference voltage is applied to this circuit, voltage potentials boosted 1 time, 2 times, 3 times ... (multiplied by integers) are applied to the dynodes of the photomultiplier tube. This circuit is compact with low power consumption and delivers high DC characteristics and pulse linearity characteristics, but the settling time becomes temporarily long.

### ● Active type divider circuit combined with Cockcroft-Walton circuit

This circuit consists of a Cockcroft-Walton circuit that generates a voltage supplied to the entire photomultiplier tube and an active type divider circuit that supplies a voltage to each dynode. In the active type divider circuit, transistors are used in place of voltage-dividing resistors for the last few dynodes. This method prevents the dynode-to-dynode voltage from being affected by the photomultiplier tube signal current, allowing good output linearity to be obtained up to 60 to 70% of the voltage divider circuit current. This circuit also features short settling time compared to when only a Cockcroft-Walton circuit is used.

### ● Ripple noise

Switching noise may get into the output signal of PMT modules by induction since high-voltage power supplies in PMT modules use a switching power supply. This induced noise is called "ripple noise." Although Hamamatsu PMT modules are designed to minimize this ripple noise, taking the following measures will reduce it even further.

- 1) Place a low-pass filter after the signal output from the PMT module.
- 2) Increase the control voltage to raise the photomultiplier tube gain and lower the amplifier gain. At Hamamatsu Photonics, ripple noise is measured with a signal load resistance of 1 MΩ and a load capacitance of 22 pF.

### ● Settling time

When the control voltage is changed, the high voltage supplied to the photomultiplier tube also changes, but there is a slight delay from the change in the control voltage. The settling time is the time required for the photomultiplier tube supply voltage to reach the specified level after changing the control voltage. At Hamamatsu Photonics, this settling time is measured usually by changing the control voltage from +1.0 V to +0.5 V.

### ● Voltage output type PMT modules

Using as a charge amplifier

Voltage output type PMT modules incorporate an operational amplifier that converts a current output from the photomultiplier tube into a voltage output. The operational amplifier has feedback resistance and capacitance, and also serves as a simple charge amplifier allowing pulse measurements such as in scintillation counting applications.

## Gate function characteristics

### ● Gate operation

If excessive light enters a photomultiplier tube, changing the dynode potential protects the photomultiplier tube electronically from excessive light input. PMT modules with a gate circuit can do this operation.

To prevent excessive light from entering, a mechanical shutter is commonly used to directly shut off excessive light. However, mechanical shutters are not suited for high-speed operation. In contrast, PMT modules with a gate circuit perform electronic gate operation with a high switching ratio. There are two methods of gate operation. In one method the photomultiplier tube is normally off and turns on when a gate signal is input. In the other method, the photomultiplier tube is normally on and turns off when a gate signal is input.

### ● Gate noise

High-speed gate pulses must be input to perform high-speed gate operation. When a gate pulse is input to a photomultiplier tube, induced noise is generated and appears in the anode signal due to interelectrode capacitance. This is called gate noise. Reducing the gate pulse voltage or noise canceling techniques are effective to some extent in decreasing this gate noise, but cannot completely eliminate it. So it is necessary to increase the photomultiplier tube gain or use a photomultiplier tube with high gain.

### ● Switching ratio

This is the ratio of the photomultiplier tube outputs when the gate is tuned on and off at a constant light level incident on the photomultiplier tube. For example, while normally off operation, if the gate-off output is 1 nA and the gate-on output is 10 μA, the switching ratio is 1 nA to 10 μA or expressed as 1 : 10<sup>4</sup>.

## Photon counting circuit characteristics

### ● Principle of photon counting

When light intensity becomes extremely low, light can be counted as individual photons. Photomultiplier tubes have an electron multiplier with excellent time resolution, high gain and yet low noise, making them ideal for photon counting measurements. In low-light-level measurement, photon counting has advantages over the analog detection method. For example, noise pulses can be easily separated, and high stability and a high S/N ratio obtained.

### ● Quantum efficiency

The most important characteristic in photon counting is the photocathode quantum efficiency that is the probability of photoelectron emission when a single photon strikes the photocathode. Since the number of photoelectrons emitted per photon is one or zero, the quantum efficiency is defined as the ratio of the number of photoelectrons emitted from the photocathode to the number of photons incident on the photocathode over a unit of time. There are various types of photocathodes. It is essential to choose a photomultiplier tube with a photocathode that provides the highest quantum efficiency at the wavelength to be measured.

### ● Detection efficiency

Detection efficiency is the ratio of the number of photomultiplier tube output pulses to the number of incident photons. The "count sensitivity" listed in this catalog is related to this detection efficiency.

### ● Count sensitivity

Count sensitivity is used to indicate the sensitivity of a photon counting head and is defined as the output count value per second when light of 1 pW enters the photon counting head (expressed in s<sup>-1</sup>·pW<sup>-1</sup>). Count sensitivity equals to the output count value (pJ<sup>-1</sup>) per photon energy of 1 pJ.

### ● Correction of count loss

The maximum count rate is a reciprocal of pulse-pair resolution (ability to discriminate between successive pulses). However, since chemiluminescence and bioluminescence occur randomly, the detected signal pulses may overlap each other, causing a counting error and decreasing the output linearity. Considering the probability of pulse overlap, the maximum effective count rate would be 1/10th of the theoretical rate. This count loss of overlapped pulses can be corrected by the following equation.

$$N = \frac{n}{1 - nt}$$

N: True count rate

n: Measured count rate

t: Pulse-pair resolution

# Precautions

## Safety precautions



### HIGH VOLTAGE

Some products listed in this catalog generate a high voltage internally. Be sure to observe the following safety measures and take sufficient precautions to prevent possible electrical shocks.

- Always turn off the power before moving, installing and inspecting the products or connecting/disconnecting the cables and connectors.
- Do not modify any part of the product and do not open the housing case. Malfunctions or electrical shocks might result and the products might overheat, smoke or catch fire.

## Handling precautions

Take the following precautions when handling PMT modules.

- Do not expose the photocathode of PMT modules to excessive light such as sunlight. If exposed, noise will increase and photocathode sensitivity will deteriorate.
- Do not touch the light input window with bare hands. Dirt and grime on the window causes loss of optical transmittance. If the window becomes soiled with dirt or grime, wipe it clean using alcohol.
- Helium will penetrate through silica (quartz) glass windows and increase noise. Avoid using or storing those PMT modules in an atmosphere where helium is present.
- Carefully check that the power supply output voltage and polarity are correct.
- Do not apply strong vibrations or impacts to PMT modules.
- Do not apply a strong tightening force to localized sections.
- Do not let moisture or dust penetrate inside.
- Consult with us if you must take special countermeasures against tough conditions such as high temperatures, high humidity or strong magnetic fields.
- When designing equipment using or incorporating products listed in this catalog, install safety interlocks (breakers, etc.) to prevent accidents from electrical shocks or excessive light input, etc.

## Warranty

Hamamatsu PMT modules and related products are warranted to the original purchaser for a period of one year after delivery. The warranty is limited to repair or replacement of defective products due to defects in workmanship or materials used in their manufacture.

Even if within the warranty period, the warranty shall not apply to failures due to misuse, mishandling, modification by the customer, or accidents such as natural or manmade disasters. The customer should inspect and test all products as soon as they are delivered.

## Ordering Information

This catalog lists PMT modules and related products currently available from Hamamatsu Photonics. Please select those products that best match your design specifications. Delivery time depends on the type of product. Some are already in stock but some require extra delivery time.

If you do not find the exact product you want in this catalog, feel free to contact our sales office nearest you. We will modify our current products or design new types to meet your specific needs.



## Main Products

### Opto-semiconductors

- Si photodiodes
- APD
- MPPC®
- Photo IC
- Image sensors
- PSD
- Infrared detectors
- LED
- Optical communication devices
- Automotive devices
- X-ray flat panel sensors
- MEMS devices
- Mini-spectrometers
- Opto-semiconductor modules

### Electron Tubes

- Photomultiplier tubes
- Photomultiplier tube modules
- Microchannel plates
- Image intensifiers
- Xenon lamps / Mercury-xenon lamps
- Deuterium lamps
- Light source applied products
- Laser applied products
- Microfocus X-ray sources
- X-ray imaging devices

### Imaging and Processing Systems

- Cameras / Image processing measuring systems
- X-ray products
- Life science systems
- Medical systems
- Semiconductor failure analysis systems
- FPD / LED characteristic evaluation systems
- Spectroscopic and optical measurement systems

### Laser Products

- Single chip laser diodes
- Laser diode bar modules
- Quantum cascade lasers
- Applied products of semiconductor lasers
- Solid state lasers / Fiber lasers
- Laser related products

## Sales Offices

### Japan:

**HAMAMATSU PHOTONICS K.K.**  
325-6, Sunayama-cho, Naka-ku,  
Hamamatsu City, Shizuoka Pref. 430-8587, Japan  
Telephone: (81)53-452-2141, Fax: (81)53-456-7889  
E-mail: intl-div@hq.hpk.co.jp

### China:

#### **HAMAMATSU PHOTONICS (CHINA) CO., LTD.**

**Main Office**  
1201 Tower B, Jiaming Center, 27 Dongsanhuan Beilu,  
Chaoyang District, 100020 Beijing, P.R. China  
Telephone: (86)10-6586-6006, Fax: (86)10-6586-2866  
E-mail: hpc@hamamatsu.com.cn

#### **Shanghai Branch**

4905 Wheelock Square, 1717 Nanjing Road West,  
Jingan District, 200040 Shanghai, P.R. China  
Telephone: (86)21-6089-7018, Fax: (86)21-6089-7017  
E-mail: hpcsh@hamamatsu.com.cn

#### **Shenzhen Branch**

14F China Merchants Tower 1#, No. 1166 Wanghai Road,  
Shekou, Nanshan District, Shenzhen, P.R. China  
Telephone: (86)755-2165-9058, Fax: (86)755-2165-9056  
E-mail: hpcsz@hamamatsu.com.cn

#### **Wuhan Branch**

Room 1005 Fanyue City T2 Building, No. 19 Guanshan  
Avenue, East Lake High-tech District, Hubei, P.R. China  
Telephone: (86)27-5953-8219  
E-mail: hpcwh@hamamatsu.com.cn

### Taiwan:

#### **HAMAMATSU PHOTONICS TAIWAN CO., LTD.**

**Main Office**  
8F-3, No.158, Section 2, Gongdao 5th Road,  
East District, Hsinchu, 300, Taiwan R.O.C.  
Telephone: (886)3-659-0080, Fax: (886)3-659-0081  
E-mail: info@hamamatsu.com.tw

### U.S.A.:

#### **HAMAMATSU CORPORATION**

**Main Office**  
360 Foothill Road, Bridgewater, NJ 08807, U.S.A.  
Telephone: (1)908-231-0960, Fax: (1)908-231-1218  
E-mail: usa@hamamatsu.com

#### **California Office**

2875 Moorpark Ave., San Jose, CA 95128, U.S.A.  
Telephone: (1)408-261-2022, Fax: (1)408-261-2522  
E-mail: usa@hamamatsu.com

### Germany, The Netherlands, Poland, Denmark, Israel:

#### **HAMAMATSU PHOTONICS DEUTSCHLAND GMBH**

**Main Office**  
Arzbergerstr. 10, 82211 Herrsching am Ammersee,  
Germany  
Telephone: (49)8152-375-0, Fax: (49)8152-265-8  
E-mail: info@hamamatsu.de

#### **Netherlands Office**

Transistorstraat 7, 1322 CJ Almere, The Netherlands  
Telephone: (31)36-5405384, Fax: (31)36-5244948  
E-mail: info@hamamatsu.nl

#### **Poland Office**

10 Ciolka Street, 126-127 01-402 Warsaw, Poland  
Telephone: (48)22-646-0016, Fax: (48)22-646-0018  
E-mail: poland@hamamatsu.de

### Danish Office

Lautruphøj 1-3, 2750 Ballerup, Denmark  
Telephone: (45)44-20-99-49, Fax: (45)44-20-99-10  
Email: info@hamamatsu.dk

### Israel Office (HAMAMATSU PHOTONICS ISRAEL LTD.)

Ha-Menofim 10 st., third floor, 4672561 Herzliya, Israel  
E-mail: Info@hamamatsu.co.il

### France, Switzerland, Belgium, Spain:

#### **HAMAMATSU PHOTONICS FRANCE S.A.R.L.**

**Main Office**  
19, Rue du Saule Trapu, Parc du Moulin de Massy,  
91882 Massy Cedex, France  
Telephone: (33)1 69 53 71 00, Fax: (33)1 69 53 71 10  
E-mail: infos@hamamatsu.fr

#### **Swiss Office**

Dornacherplatz 7, 4500 Solothurn, Switzerland  
Telephone: (41)32-625-60-60, Fax: (41)32-625-60-61  
E-mail: swiss@hamamatsu.ch

#### **Belgian Office**

Axisparc Technology, Rue Andre Dumont 7  
1435 Mont-Saint-Guibert, Belgium  
Telephone: (32)10 45 63 34, Fax: (32)10 45 63 67  
E-mail: info@hamamatsu.be

#### **Spanish Office**

C. Argenters, 4 edif 2 Parque Tecnológico del Vallés  
08290 Cerdanyola (Barcelona), Spain  
Telephone: (34)93 582 44 30, Fax: (34)93 582 44 31  
E-mail: infospain@hamamatsu.es

### North Europe and CIS:

#### **HAMAMATSU PHOTONICS NORDEN AB**

**Main Office**  
Torshamnsgatan 35 16440 Kista, Sweden  
Telephone: (46)8-509 031 00, Fax: (46)8-509 031 01  
E-mail: info@hamamatsu.se

#### **Russian Office**

11, Christoprudny Boulevard, Building 1, Office 114,  
101000, Moscow, Russia  
Telephone: (7)495 258 85 18, Fax: (7)495 258 85 19  
E-mail: info@hamamatsu.ru

### Italy:

#### **HAMAMATSU PHOTONICS ITALIA S.R.L.**

**Main Office**  
Strada della Moia, 1 int. 6, 20044 Arese (Milano), Italy  
Telephone: (39)02-93 58 17 33, Fax: (39)02-93 58 17 41  
E-mail: info@hamamatsu.it

#### **Rome Office**

Viale Cesare Pavese, 435, 00144 Roma, Italy  
Telephone: (39)06-50 51 34 54  
E-mail: inforoma@hamamatsu.it

### United Kingdom:

#### **HAMAMATSU PHOTONICS UK LIMITED**

**Main Office**  
2 Howard Court, 10 Tewin Road, Welwyn Garden City,  
Hertfordshire AL7 1BW, UK  
Telephone: (44)1707-294888, Fax: (44)1707-325777  
E-mail: info@hamamatsu.co.uk

### South Africa Contact:

9 Beukes Avenue, Highway Gardens, Edenvale  
1609 South Africa  
Telephone/Fax: (27)11-609-0367

Windows is a registered trademark of Microsoft Corporation in the United States and other countries.

Other product names and software names mentioned in this catalog may be trademarks or registered trademarks of their respective owners and a detailed listing is omitted.

• Information in this catalog is believed to be reliable. However, no responsibility is assumed for possible inaccuracies or omission. Specifications are subject to change without notice. No patent rights are granted to any of the circuits described herein. © 2022 Hamamatsu Photonics K.K.

• Please thoroughly read the precautions and the prohibited uses included in the user manual before installation and use.

## Electron Tube Division, HAMAMATSU PHOTONICS K.K.

314-5, Shimokanzo, Iwata City, Shizuoka Pref., 438-0193, Japan  
Telephone: (81)539/62-5248, Fax: (81)539/62-2205

www.hamamatsu.com