

InAs photovoltaic detectors



P10090 series, P7163

Low noise, high reliability infrared detectors (up to 3 μm band)

InAs photovoltaic detectors have high sensitivity in the infrared region around 3 μm as with PbS photoconductive detectors, and also feature low noise, high speed and high reliability. Various types are available, including non-cooled type, thermoelectrically cooled type (P10090 series), and liquid nitrogen cooled type (P7163) that delivers high performance.

Features

- Low noise
- High detectivity (D*)
- High reliability
- Available in multi-element arrays (custom product)

Applications

- Gas analysis
- Laser detection
- Infrared spectrophotometry
- Radiation thermometer

Options (sold separately)

- Heatsink for one/two-stage TE-cooled type **A3179-01**
- Temperature controller **C1103-04**
- Infrared detector module with preamp **C12492-210**
- Amplifiers for InAs photovoltaic detector
(P10090-01: C4159-07, P10090-11/-21: C4159-06,
P7163: C4159-05)

Structure/Absolute maximum ratings

Type No.	Dimensional outline/ Window material*1	Package	Cooling	Photosensitive area (mm)	Absolute maximum ratings					
					Thermoelectric cooler allowable current (A)	Thermistor power dissipation (mW)	Reverse voltage V _R (V)	Operating temperature T _{opr} *2 (°C)	Storage temperature T _{stg} *2 (°C)	Maximum incident light level (W)
P10090-01	①/S	TO-5	Non-cooled	φ1	-	-	0.5	-40 to +80	-40 to +80	0.6
P10090-11	②/S	TO-8	One-stage TE-cooled		1.5	0.2				
P10090-21			Two-stage TE-cooled		1.0					
P7163	③/S	Metal dewar*3	LN2	φ1	-	-	-40 to +60	-55 to +60		

*1: S=Sapphire glass

*2: No dew condensation

When there is a temperature difference between a product and the surrounding area in high humidity environments, dew condensation may occur on the product surface. Dew condensation on the product may cause deterioration in characteristics and reliability.

*3: Liquid nitrogen retention time prior to shipment: 12 hr

Note: Exceeding the absolute maximum ratings even momentarily may cause a drop in product quality. Always be sure to use the product within the absolute maximum ratings.

Electrical and optical characteristics (Typ. unless otherwise noted)

Type no.	Chip temperature T _{chip} (°C)	Peak sensitivity wavelength λ _p (μm)	Cutoff wavelength λ _c (μm)	Photo sensitivity S λ=λ _p (A/W)	Shunt resistance R _{sh}		D* (λ _p , 1200, 1)		NEP λ=λ _p (W/Hz ^{1/2})	Rise time t _r V _R =0 V R _L =50 Ω 0 to 63% (μs)
					Min. (Ω)	Typ. (Ω)	Min. (cm · Hz ^{1/2} /W)	Typ. (cm · Hz ^{1/2} /W)		
P10090-01	25	3.35	3.65	1.0	40	70	3.0 × 10 ⁹	4.5 × 10 ⁹	1.5 × 10 ⁻¹¹	0.70
P10090-11	-10	3.30	3.55	1.2	250	400	1.0 × 10 ¹⁰	1.6 × 10 ¹⁰	5.3 × 10 ⁻¹²	0.45
P10090-21	-30	3.25	3.45		1000	1300	2.0 × 10 ¹⁰	3.2 × 10 ¹⁰	2.8 × 10 ⁻¹²	0.30
P7163	-196	3.00	3.1	1.3	1 × 10 ⁵	1 × 10 ⁶	3.5 × 10 ¹¹	6.0 × 10 ¹¹	1.5 × 10 ⁻¹³	0.10

Spectral response (D*)

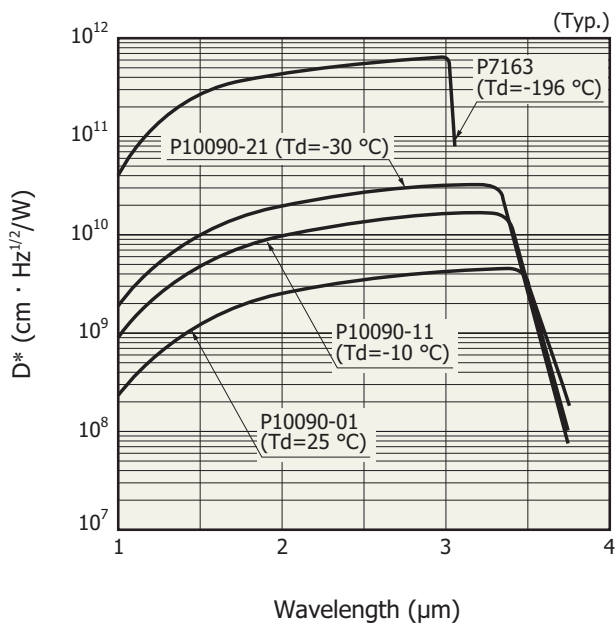

Spectral response

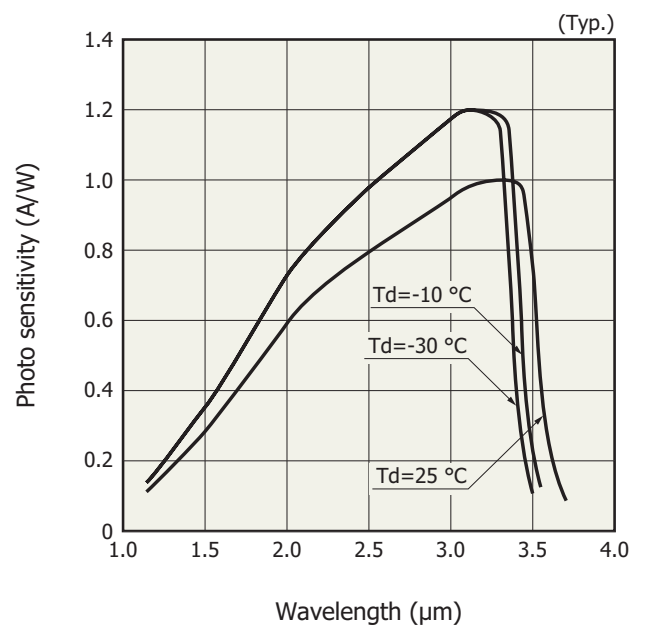

Dark current vs. reverse voltage

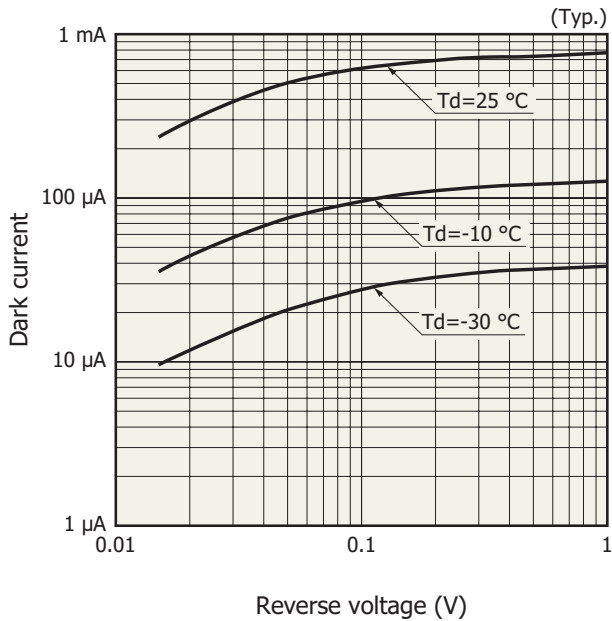

Shunt resistance vs. element temperature (P10090 series)

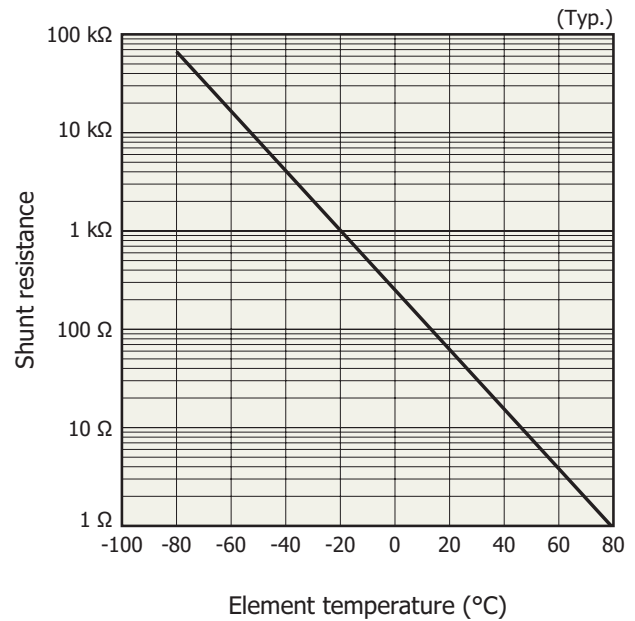

TE-cooler specifications (Ta=25 °C, unless otherwise noted)

Parameter	Condition	Symbol	Min.	Typ.	Max.	Unit
TE-cooler allowable current	One-stage TE-cooled	Ic max	-	-	1.5	A
	Two-stage TE-cooled		-	-	1.0	
TE-cooler allowable voltage	One-stage TE-cooled	Vc max	-	-	1.0	V
	Two-stage TE-cooled		-	-	1.2	
Thermistor resistance		Rth	8.1	9.0	9.9	kΩ
Thermistor B constant	T1=25 °C, T2=-30 °C	B	-	3298	-	K
Thermistor power dissipation		Pth	-	-	0.2	mW

Linearity

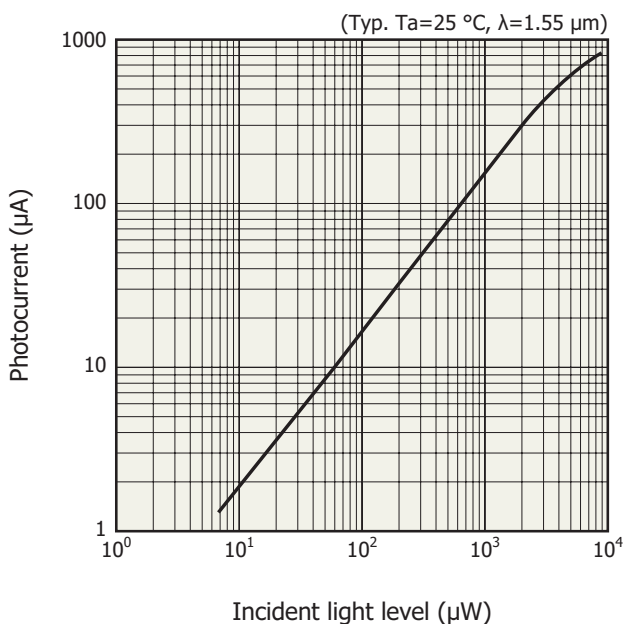

Sensitivity uniformity

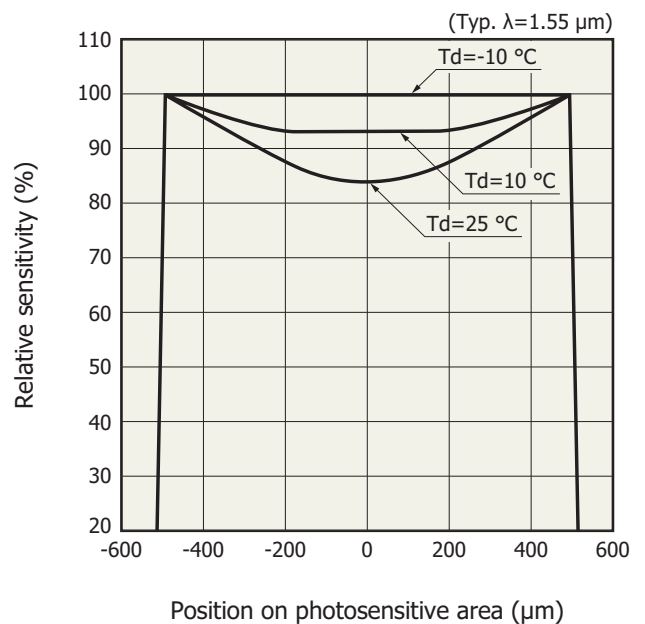

Current vs. voltage of TE-cooled type

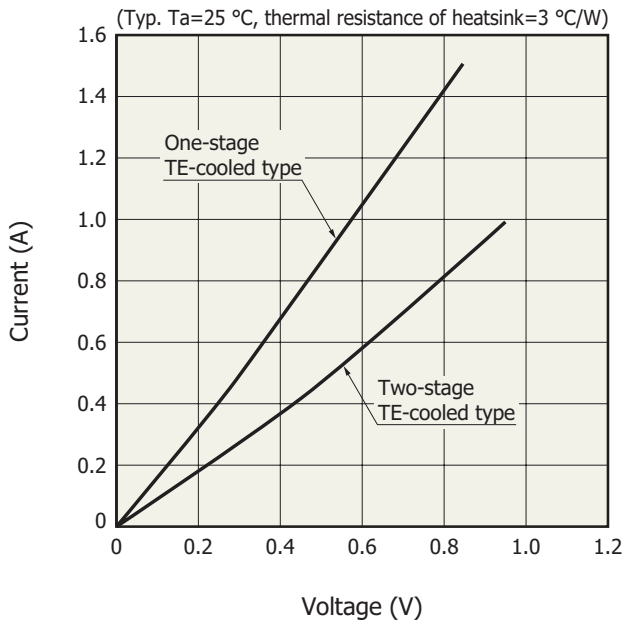

Cooling characteristics of TE-cooled type

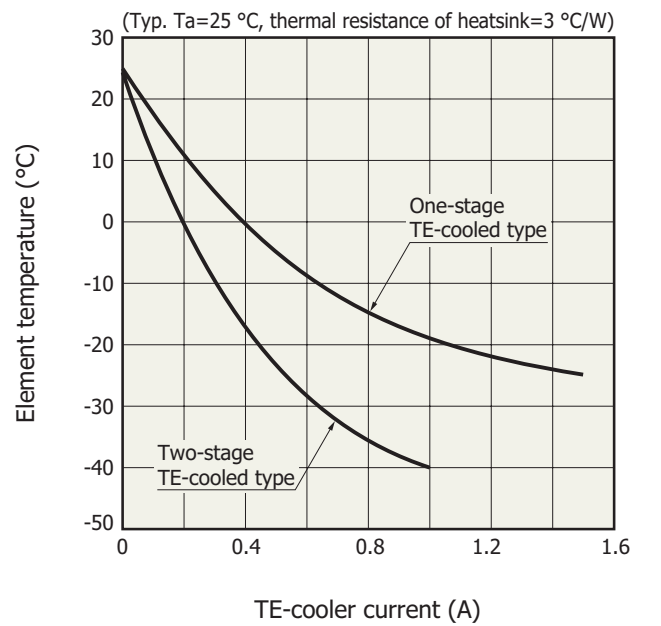

Thermistor temperature characteristic

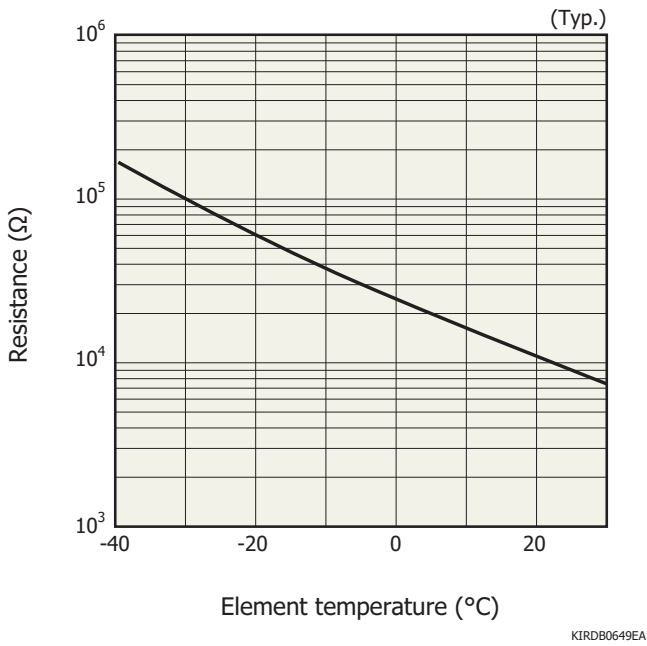

Measurement circuit

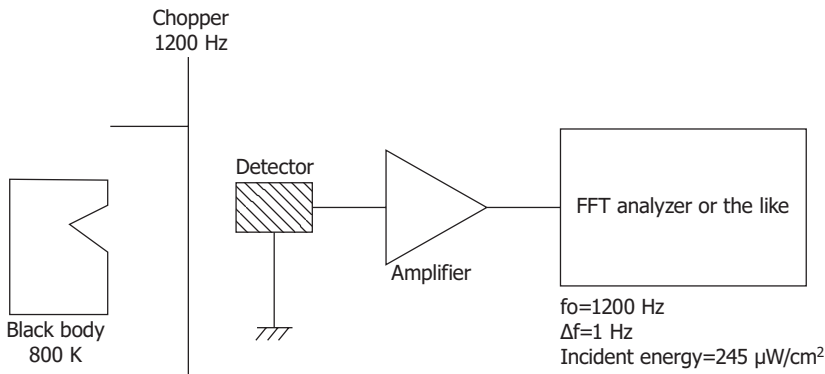

KIRDC0127EA

Dimensional outlines (unit: mm)

① P10090-01

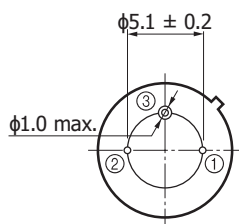
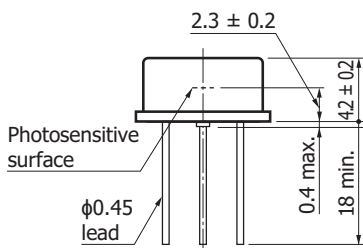
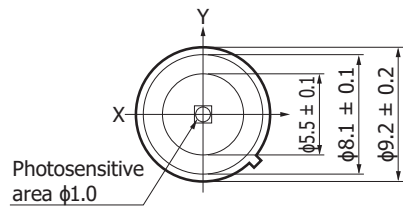

Distance from photosensitive area center to cap center
 $-0.2 \leq X \leq +0.2$
 $-0.2 \leq Y \leq +0.2$

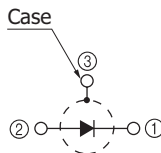

② P10090-11/-21

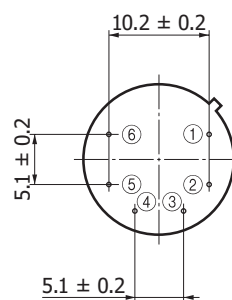
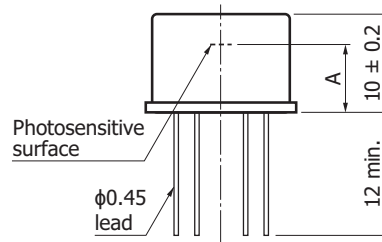
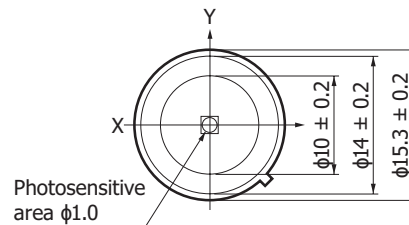

Distance from photosensitive area center to cap center
 $-0.3 \leq X \leq +0.3$
 $-0.3 \leq Y \leq +0.3$

- ① Detector (anode)
- ② Detector (cathode)
- ③ TE-cooler (-)
- ④ TE-cooler (+)
- ⑤ ⑥ Thermistor

	P10090-11	P10090-21
a	4.5 ± 0.2	6.9 ± 0.2

KIRDA0264EB

KIRDA0263EB

