

Technical note

June 2018



ORCA-Flash4.0 V3

Digital CMOS camera
C13440-20CU

Table of contents

1. Spec Chart	P2
2. ORCA-Flash4.0 V2/V3 Comparison Chart	P3
3. Key Features	P3
3-1. Readout noise	
3-2. Quantum efficiency	
3-3. Speed/Connectivity	
3-4. Sub-array readout or Region of Interest (ROI)	
3-5. Binning readout	
3-6. Real-time defect pixel correction	
3-7. Photo Response Non-Uniformity (PRNU) and Dark Signal Non-Uniformity (DSNU)	
3-8. High Contrast Mode	
4. Readout Modes	P7
4-1. Diagram of sensor showing two halves	
4-2. Explanation of what readout is	
4-3. W-VIEW Mode	
4-4. Lightsheet Readout Mode (Patented)	
4-5. Dual Lightsheet Readout Mode	
5. Data Management (Exclusive to ORCA-Flash4.0 V3)	P10
5-1. 8 bit/12 bit LUT	
5-2. Data extraction (ORCA-Flash4.0 V3 Exclusive Feature)	
6. Triggering	P11
6-1. Master Pulse	
6-2. Trigger output	
7. Various Timing Charts	P13
7-1. Explanation of timing charts	
7-2. Normal area mode	
7-3. Light sheet mode	
8. Software Support	P18
8-1. DCAM-API	
8-2. DCAM-SDK & DCIMG-SDK	
8-3. GPUs	
8-4. Third party software support/options	
9. Understanding SNR	P19
9-1. SNR and rSNR chart	
10. Application Examples	P20
10-1. Super Resolution Microscopy	
10-2. Lightsheet Microscopy	
11. Diagrams	P21
11-1. Dimensional Outlines	
11-2. System Configuration	
11-3. Options	

1. Spec Chart

Product number	C13440-20CU
Imaging device	sCMOS
Cell (pixel) Size (μm^2)	6.5×6.5
Pixel Array (horizontal by vertical)	2048×2048
Effective Area (horizontal by vertical in mm)	13.312×13.312

Peak Quantum Efficiency (QE)*1	82 % @ 560 nm
Dynamic Range*1	37 000 : 1

	USB 3.0	With Optional Camera Link Board for PC
Readout Noise (N ^r) median in electrons slow scan*1	0.8 @ 30 fps	0.8 @ 30 fps
Readout Noise (N ^r) rms in electrons slow scan*1	1.4 @ 30 fps	1.4 @ 30 fps
Readout Noise (N ^r) median in electrons standard scan*1	1.0 @ 40 fps	1.0 @ 100 fps
Readout Noise (N ^r) rms in electrons standard scan*1	1.6 @ 40 fps	1.6 @ 100 fps
Maximum Full Resolution Frame Rate (fps)	40	100

Cooling Temperature Readout	Yes
Dark Current (electrons/pixel/s) – Air Cooled to -10 °C	0.06
Dark Current (electrons/pixel/s) – Water Cooled to -10 °C	0.06
Dark Current (electrons/pixel/s) – Water Cooled to -30 °C	0.006
Full Well Capacity in electrons*1	30 000

Digital Outputs (with programmable LUT)	16, 12, 8 bit
Readout Modes	Normal Area, Lightsheet, W-VIEW Mode, Dual Lightsheet

Binning	2×2/4×4
---------	---------

Master Pulse Generator (Pulse Modes)	Free running, Start Trigger, Burst
Master Pulse Generator (Pulse Interval in 1 μs increments)	10 μs to 10 s

Hot Pixel Correction	Off, Low, Medium, High
Dark Signal Non-Uniformity (DSNU)*1	0.3 electrons rms
Photo Response Non-Uniformity (PRNU) at half level of full light range (15 000 electrons)*1	0.06 % rms
Photo Response Non-Uniformity (PRNU) at low light level (700 electrons)*1	0.3 % rms
Linearity error, full light range (EMVA 1288 standard)*1	0.5 %
Linearity error, low light range (< 500 electrons signal)*1	0.2 %/Less than approx. 1 e-absolute error

On-camera Connectivity	Both USB 3.0 and Camera Link*2
V2 Compatibility Mode (for use with legacy software)	Yes
Lens mount	C-mount

*1 Typical value *2 Enabled with optional Camera Link board for PC

2.

ORCA-Flash4.0 V2/V3 Comparison Chart

Model Type number	ORCA-Flash4.0 V3 C13440-20CU	ORCA-Flash4.0 V2 C11440-22CU (SN/100001-)	ORCA-Flash4.0 V2 C11440-22C/-22CU (-SN/009999)
QE	82 %	82 %	72 %
Readout noise	Slow: 0.8 (med)/1.4 (rms) Fast: 1.0 (med)/1.6 (rms)		
Cooling temperature	-10 °C (Air)/ -10 °C (Water)/ -30 °C (Max)	-10 °C (Air)/ -20 °C (Water)/ -30 °C (Max)	
Dark current	0.06 electrons/pixels (-10 °C) 0.006 electrons/pixels (-30 °C)		
Linearity	Linearity error, full light range (EMVA 1288 standard) 0.5 % Linearity error, low light range (< 500 e- signal) 0.2 %/Less than approx. 1 e- absolute error	<3 %	
Frame rate	100 (CL)/40 (USB)	100 (CL)/30 (USB)	
Slow scan	✓		
Light sheet mode	✓(CL/USB)	✓(CL only)	
Global reset trigger	✓		
W-VIEW Mode	✓	—	
V2 compatible mode	✓	—	
Data extraction	✓	—	
8 bit/12 bit output	✓	—	
High contrast mode	✓	—	
Hot pixel correction	✓ (Multi-level)	✓ (ON/OFF)	
Master pulse	✓	—	
Dual light sheet mode	✓	—	
Temperature readout	✓	—	

3.

Key Features

3-1. Readout noise

3-1-1. Readout noise

The main factors that determine the detection limit of the image sensor are the dark current and readout noise of the sensor, important parameters that determine the performance of the camera.

Of the two, Dark current can be reduced by cooling the sensor, making readout noise the most important parameter.

3-1-2. What is readout noise?

It is the random noise generated within the charge-to-voltage conversion amplifier when reading out the charge.

3-1-3. Readout noise reduction method for CMOS image sensor

Cameras using the latest CMOS technology have greatly reduced the variations in the amplifier for each pixel.

By optimizing the pixel amplifier, increasing the gain and implementing CDS (Correlated Double Sampling) on the sensor, noise is dramatically reduced.

3-1-4. Readout noise measurement method

The CCD image sensor has one readout amplifier per sensor. Therefore, the readout noise measured by performing several readouts in each pixel and the readout noise measured in multiple pixels of one image are essentially equivalent. Therefore, the readout noise can be evaluated from a single image.

As CMOS image sensor has an amplifier for each pixel, the readout noise is different for each pixel. Therefore, the readout noise is first measured for each pixel.

The central value when the pixels are arranged from low to high noise is called the median. Compared to the average value, it represents the typical noise value unaffected by the maximum and minimum values. The rms noise is calculated from both the positive and negative errors with respect to the average value. It statistically represents the noise variation for each pixel.

3-1-5. Readout noise performance of ORCA-Flash4.0 V3

Fig. 1 shows the frequency distribution of the readout noise in each pixel of ORCA-Flash4.0 V3. It can be seen from the readout noise of 1.0 electron (median) and 1.6 electrons (rms) that the majority of pixels have very low noise. This achieves low readout noise as compared to the commercialized any other scientific CMOS image sensor. Moreover, this value is the performance for high-speed readout of 100 frames/second at 4 megapixels, which cannot be achieved by the old generation CMOS image sensor. The noise can be reduced further by using the slow scan mode lowering the readout noise to 0.8 electrons (median) or 1.4 electrons (rms).

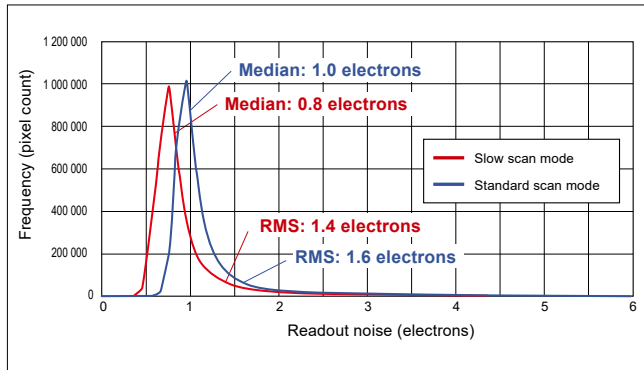

Fig. 1 ORCA-Flash4.0 V3 readout noise distribution

3-2. Quantum efficiency

With carefully designed pixels and on-chip lens technology, its Gen II sCMOS sensor provides high QE across the range of wavelengths and offers greater sensitivity than conventional sCMOS cameras, even EM-CCDs.

In low-light fluorescent imaging, the ORCA-Flash4.0 V3 enables not only excellent sensitivity but also stable imaging acquisition capabilities compared to EMCCDs which have lower relative SNR due to multiplicative noise in the on-chip gain. (See Fig. 2)

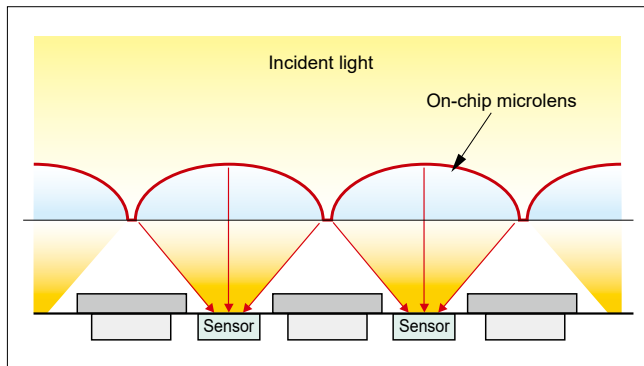

Fig. 2 Structural diagram of the on-chip microlens

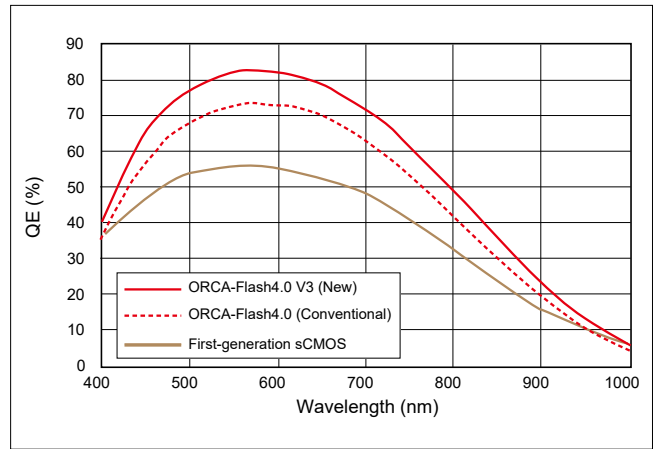

Fig. 3 Spectral response

3-3. Speed/Connectivity

3-3-1. Frame rate (readout speed)

The frame rate (readout speed) refers to the number of images that can be continuously produced and is specified in frames per second (fps).

The maximum full frame rate of the ORCA-Flash4.0 V3 is 100 frames/s (at 2048×2048 pixels) and is achieved using a simultaneous two-line parallel readout using the column A/D.

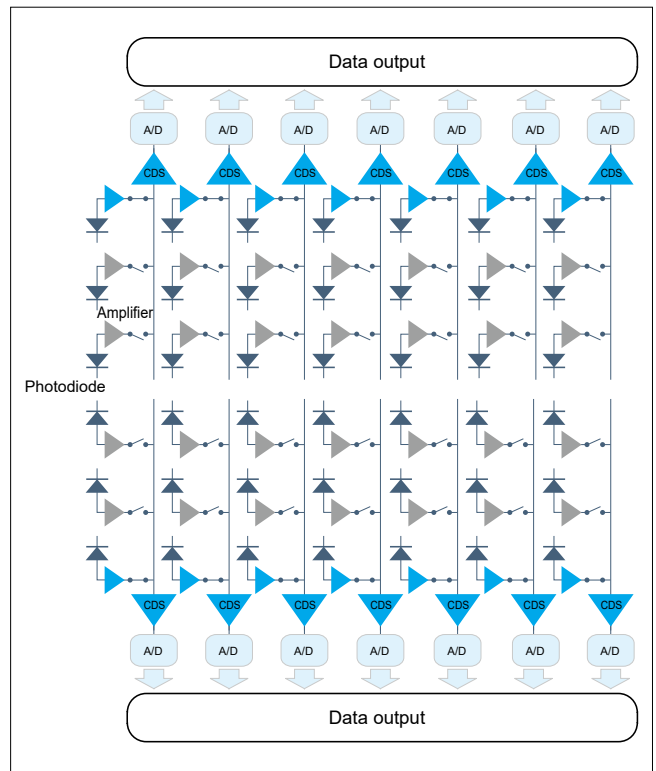

Fig. 4 Readout circuit in a CMOS image sensor

3-3-2. Output/control interface

ORCA-Flash4.0 series cameras are equipped with a Camera Link interface and USB 3.0 interface as the image output and control interfaces. Note that since the interface connected to the camera is automatically enabled, manual switching is not required.

3-3-3. Camera Link interface

When connecting with the Camera Link interface, images of 4 megapixel and 16 bit each can be transferred to a computer in 100 frames/s (full frame).

Standards	Camera Link 80 bit configuration equivalent
Pixel clock	85 MHz
Pixel output	16 bit×5 pixels/clock

3-3-4. USB 3.0 interface

The USB 3.0 interface is a general-purpose interface with a maximum speed of 500 MB/sec. It comes standard with many computers and is equipped in many notebook computers. The ORCA-Flash4.0 V3 offers user-controllable Look Up Tables (LUT) for 8 bit or 12 bit data in order to record only the necessary range of digital output. With this capability, users can not only reduce image data volume but also improve the camera frame rates by eliminating the need to record unnecessary image data.

Effective number of pixels	ORCA-Flash4.0 V2		ORCA-Flash4.0 V3	
	Digital output	Frame rate	Digital output	Frame rate
2048×2048	16 bit	30 frames/s	16 bit	40 frames/s
			12 bit	53 frames/s
			8 bit	80 frames/s
1920×1080	16 bit	60 frames/s	16 bit	75 frames/s
			12 bit	100 frames/s
			8 bit	151 frames/s

Table 1 Readout speed comparison when using USB 3.0

3-4. Sub-array readout or Region of Interest (ROI)

Sub-array readout is a method of reading the sensor in which the output images are comprised of only the pixels in the user selectable region of interest (ROI). Since less data is being readout and transferred this method can offer increased frame rates with no increase in read noise. Unlike CCD sensors in which the areas outside of the ROI need to be transferred and discarded, the architecture of CMOS sensors allow the read out of only the ROI itself. Because of this scheme, frame rates increase inversely to the number of pixels read out.

The maximum sub-arrayed readout speed of the ORCA-Flash4.0 V3 is 25 600 frames/second when an 8 pixel (vertical) region is set on the center-line of the sensor.

The configurable area is two vertically symmetrical positions centering on the center of the screen. When a single target area is used, the fastest readout is possible by setting the center of the screen. Further, the configurable position and size are in 4-line increments.

Number of pixels in vertical direction	Number of pixels in horizontal direction			
	Standard scan	Slow scan	USB 3.0 Standard scan (16 bit)	
	2048		512	1024/1536/2048
2048	100	30	100	40
1024	200	60	200	80
512	400	120	400	160
256	801	240	801	320
128	1603	481	1603	641
64	3206	962	3206	1282
8	25 655	7696	25 655	9329

Table 2 Readout method, number of pixels and readout speed

3-5. Binning readout

Binning is a method of adding the signal of adjacent pixels together to achieve high sensitivity at the cost of resolution. Binning can improve the signal to noise and frame rates of images. The ORCA-Flash4.0 V3 does in-camera binning of either 2×2 or 4×4 pixels with a resultant increase in S/N of 2× and 4×, respectively. As an illustration, a 2×2 bin of the entire sensor (2048×2048) would result in a quadrupling of the signal in each pixel, a 2 fold increase in S/N and an image that is 1024×1024 pixels. The resultant increase in speed would depend on the output interface being used and is illustrated below in Table 3.

Number of pixels in vertical direction	Binning 2×2, 4×4		
	Camera Link		USB 3.0 (Slow scan)
	Standard scan	Slow scan	
2048	100	30	30
1024	200	60	60
512	400	120	120
256	801	240	240
128	1603	481	481
64	3206	962	962
8	25 655	7696	7696

* The readout speed is when the center of the screen is measured (frames/s)

Table 3 Readout speed of binning readout method

3-6. Real-time defect pixel correction

There are a few pixels in CMOS image sensors that have slightly higher readout noise performance compared to surrounding pixels. The camera has real-time variant pixel correction features to improve image quality.

This correction is performed in real-time with no impact on image readout speed. The correction function can be turned on or off in software and the camera defaults to the ON condition when powered up.

User selectable correction levels and associated exposure time examples are listed below.

Correction level for white spots	Exposure time	Ratio of the number of pixels to be corrected to the number of all pixels
High	1 second or longer exposure time	Approximately 0.1 %
Medium (Default)	1 second or shorter exposure time	Approximately 0.05 %
Low	10 ms (default) or shorter exposure time	Less than 0.001 %

3-7. Photo Response Non-Uniformity (PRNU) and Dark Signal Non-Uniformity (DSNU)

Quantitative accuracy is a requirement for scientific cameras. In order to achieve excellent quantitative performance, good linearity, reduced fixed pattern noise and minimal pixel differences are needed, allowing the user to acquire uniform background images.

Especially, important for super resolution imaging, such as localization methods, since pixel differences generate a controversial impact on the precision of single molecule position. Hamamatsu builds in outstanding uniform image quality using of our many years of knowledge and experience with digital circuit technology.

Our attention to detail delivers outstanding linearity, especially at low light, and offers improved photon response non-uniformity (PRNU) and dark signal non-uniformity (DSNU) to minimize pixel differences and reduce fixed pattern noise.

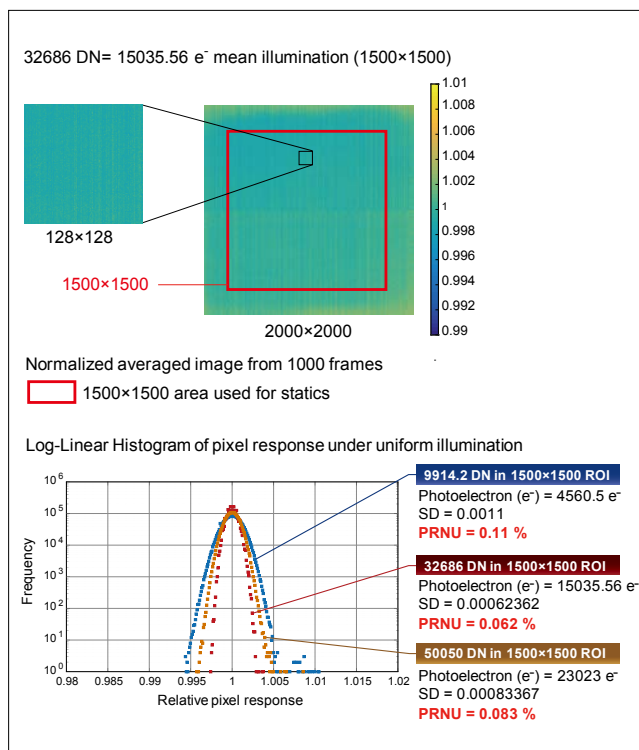

Fig. 5 Measurement example of photo-response non uniformity under uniform illumination

3-8. High Contrast Mode

CMOS cameras have the ability to detect relatively low signals in the presence of background signal. However, sometimes these images present visually as low in contrast and lacking sharpness. Hamamatsu's Enhanced Visualization Mode (High Contrast Mode) enriches the visual contrast of the image while maintaining the raw and quantitative data in the image stored to disk.

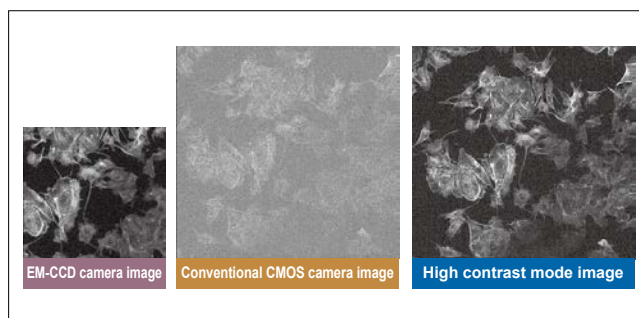

Fig. 6 High contrast mode image and comparison of field of view (All images based on LUT)

4. Readout Modes

4-1. Diagram of sensor showing two halves

The camera reads out the image sensor from the center line to the top and from the center line to the bottom simultaneously (center line is depicted in red line in the diagram).

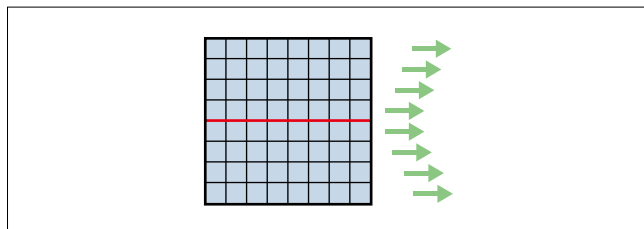

Fig. 7 Normal area mode readout direction

4-2. Explanation of what readout is

4-2-1. Rolling shutter/Global shutter

Exposure and readout methods of CMOS image sensors are classified into two types. They are rolling shutter and global shutter.

Rolling shutter exposure is achieved by exposing vertical lines slightly offset in time compared to subsequent lines. (See Fig. 8) While it is possible to capture a segment of the rolling shutter exposure so that all the pixels in the resultant image are collected at the same instant (see Global exposure timing output below), most biological samples move at a relatively slow enough speed that rolling shutter has become the preferred method of sensor reading in CMOS cameras. For some applications the rolling shutter can be customized to optimize readout methods such as Lightsheet readout (see below).

In contrast, global shutter readout exposes the light to all pixels of the sensor at the same moment in time. For some applications this is advantageous but comes at the expense of slower frame rates and increased noise. (Again, see Fig. 8)

The ORCA-Flash4.0 V3 sensor uses rolling shutter readout.

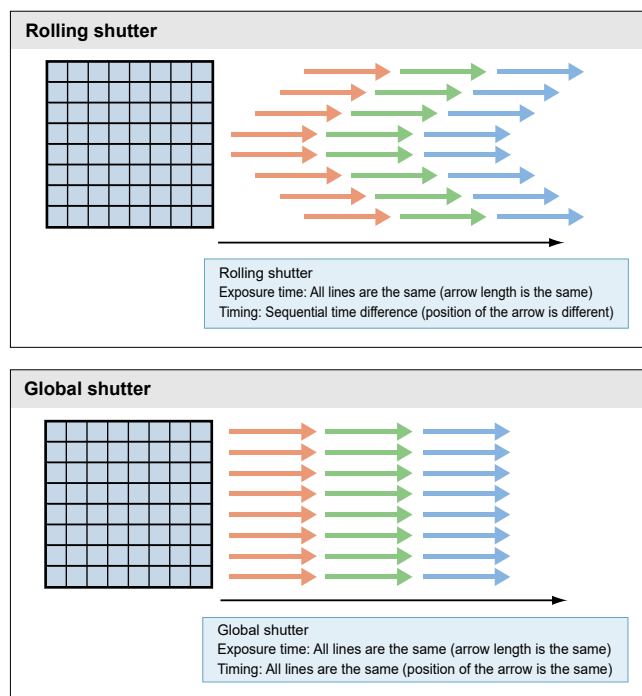

Fig. 8 Readout timing of rolling shutter and global shutter

4-3. W-VIEW Mode

The exposure time and the position of sub-array readout can be set for the top half area and the bottom half area independently in W-VIEW Mode. This function is optimized for simultaneous image acquisition of dual wavelength images., especially using W-VIEW GEMINI made by Hamamatsu.

4-3-1. Readout direction

The readout direction can be set for the top half area and the bottom half area independently in W-VIEW Mode. (Fig. 9, 10, 11, 12)

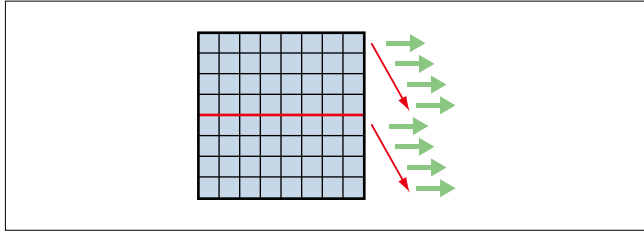

Fig. 9 Top: top to center/Bottom: center to bottom

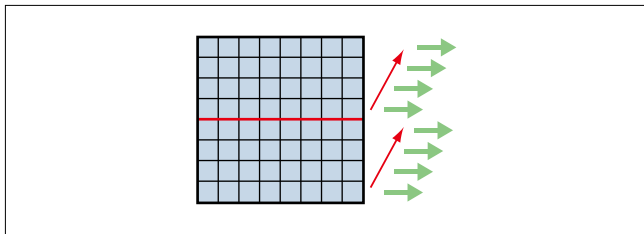

Fig. 10 Top: center to top/Bottom: bottom to center

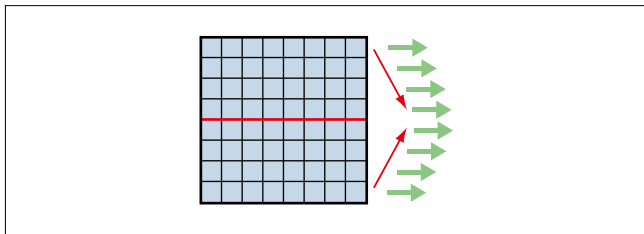

Fig. 11 Top: top to center/Bottom: bottom to center

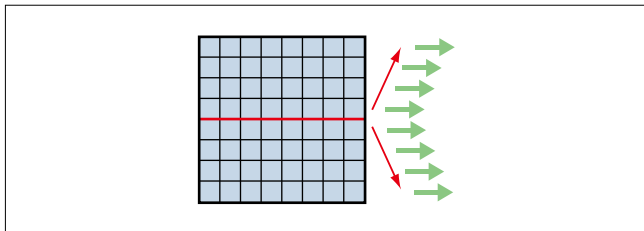

Fig. 12 Top: center to top/Bottom: center to bottom

4-4. Lightsheet Readout Mode (Patented)

Lightsheet Readout Mode is a unique and patented method of reading the CMOS image sensor in the ORCA-Flash4.0 V3 camera which provides improved control over the rolling shutter mechanism.

By finely synchronizing the camera readout with the illumination scan, scattered light is rejected allowing images of higher signal to noise ratios to be acquired.

Detailed information about Lightsheet Readout Mode is published on our website.

Website

<http://www.hamamatsu.com/jp/en/technology/innovation/lightsheetreadout/index.html>

4-4-1. Readout direction

The camera reads out from the center line to the top line and to the bottom line simultaneously in normal area mode. (Fig. 13)

The camera reads out from the top to the bottom line or from the bottom to the top line in Lightsheet Readout Mode. (Fig. 14)

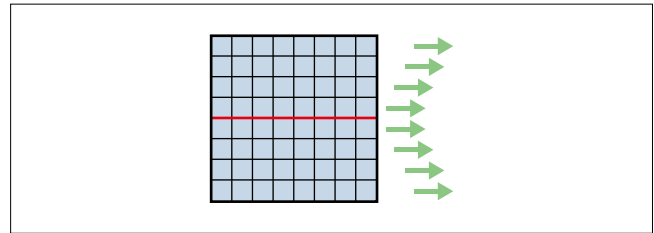

Fig. 13 Normal area mode

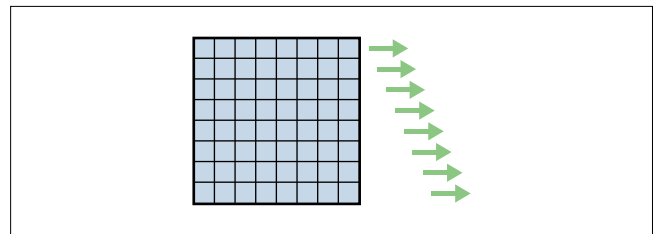

Fig. 14 Lightsheet Readout Mode

- Top to bottom readout (Fig. 15): The data is readout from the top to the bottom line.
- Bottom to top readout (Fig. 16): The data is readout from the bottom to the top line.

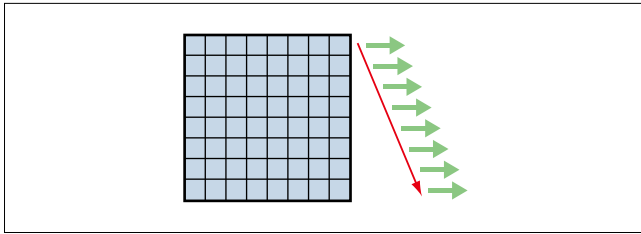

Fig. 15 Top to bottom readout

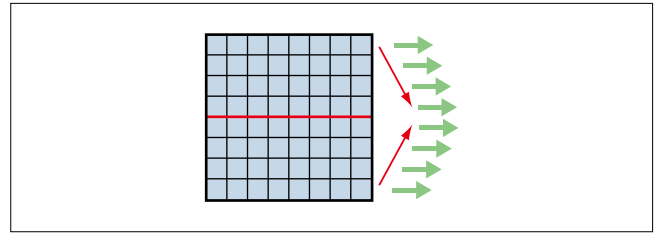

Fig. 19 Top: top to center/Bottom: bottom to center

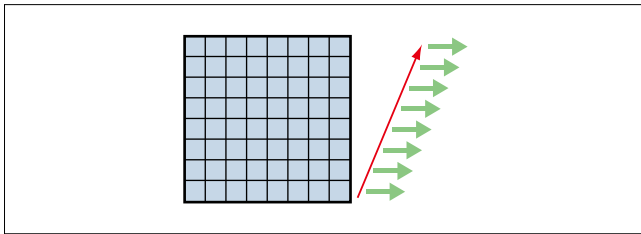

Fig. 16 Bottom to top readout

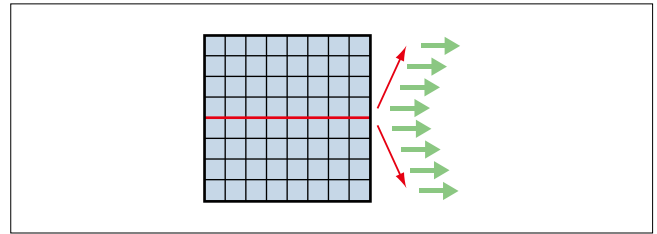

Fig. 20 Top: center to top/Bottom: center to bottom

4-5. Dual Lightsheet Readout Mode

Dual Lightsheet Readout Mode is another unique feature of CMOS image sensor which provides improved control over the rolling shutter mechanism.

Dual Lightsheet Readout Mode can achieve a frame rate that is twice as fast as that of the Lightsheet Readout Mode listed above. The sub-array can be independently positioned in each half (top or bottom) of the sensor in Dual Lightsheet Readout Mode.

4-5-1. Readout direction

The readout direction can be set for the top half area and the bottom half area independently in Dual Lightsheet Readout Mode. (Fig. 17, 18, 19, 20)

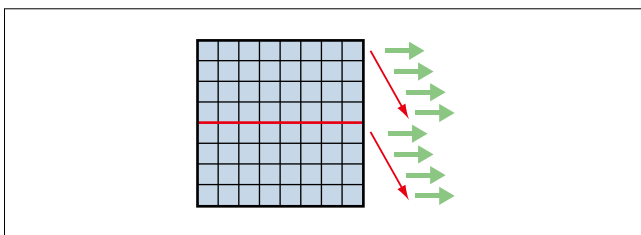

Fig. 17 Top: top to center/Bottom: center to bottom

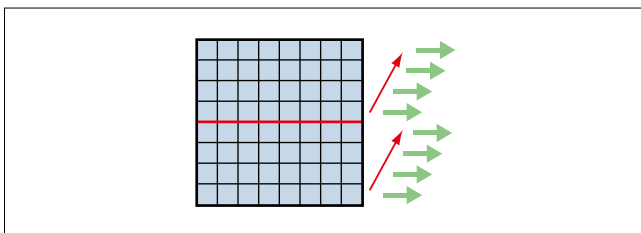

Fig. 18 Top: center to top/Bottom: bottom to center

5. Data Management (Exclusive to ORCA-Flash4.0 V3)

5-1. 8 bit/12 bit LUT

Selectable Pixel Bit Depth

Using the 8 bit (256 gray levels) or 12 bit (4096 gray levels) depth is a method to reduce the image data volume to a user significant resolution.

12 bit digital output: The data is reduced to 3/4, of the 16 bit output.

8 bit digital output: The data is reduced to 1/2, of the 16 bit output.

Thus 8 bit or 12 bit digital output can also boost the USB 3.0 interface frame rates, while reducing your image data volume.

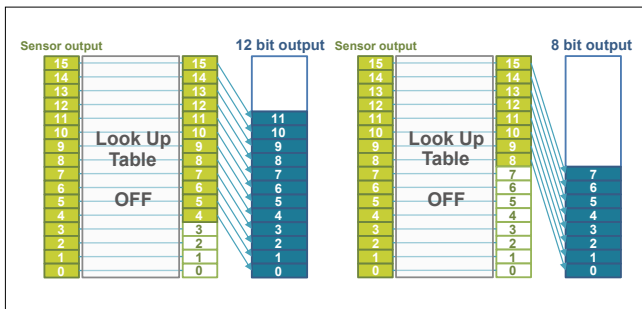

Fig. 21 LUT OFF

User-Controllable Look Up Table

The reduced 8 or 12 bit-depth acquisition can result in the compression of pixel intensity data thereby reducing intensity resolution.

The User-Controllable Look Up Table (LUT) can be used to regain intensity resolution by allowing a selectable, reduced range, of intensities to mapped into the reduced bit-depth.

Selectable LUT is adjustable up to the 16 bit-depth resolution.

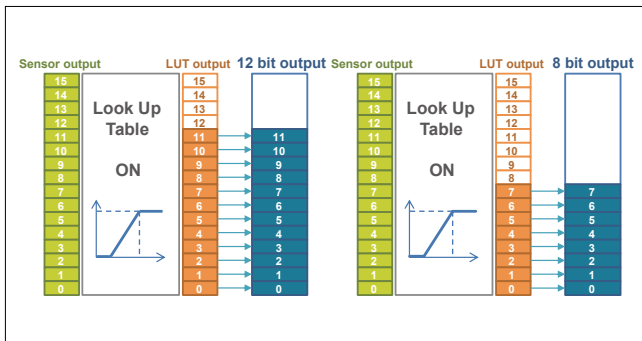

Fig. 22 LUT ON

5-2. Data extraction (ORCA-Flash4.0 V3 Exclusive Feature)

Data extraction is a function to reduce the amount of data by compressing data of unrequired area. User can specify the required area in units of 4x4 pixels using camera driver software "DCAM-API". The "DCAM-API" reconstructs the original image from the output data.

The data extraction process is performed in real-time without sacrificing the readout speed at all.

The extracted area should be less than 3/4 of the full resolution image size.

When using sub-array readout mode, the vertical sub-array size should be more than 128 lines for Normal Area Mode and Lightsheet Readout Mode, the vertical sub-array size should be more than 64 lines for W-VIEW Mode and Dual Lightsheet Readout Mode.

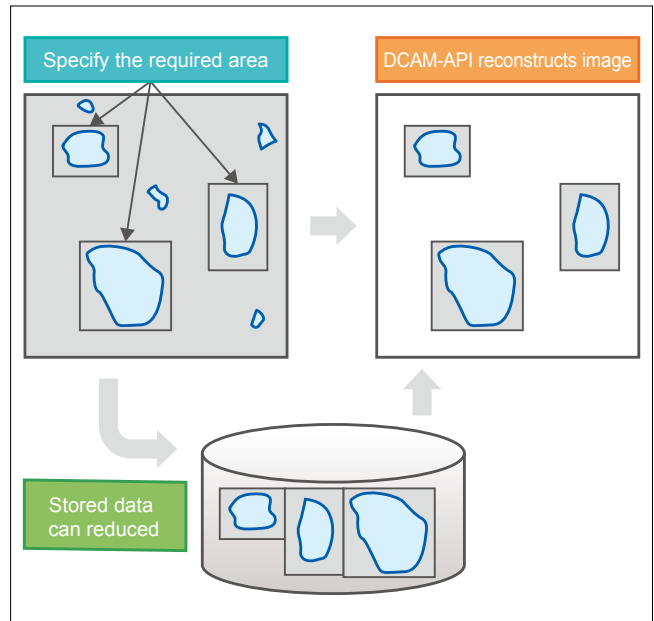

Fig. 23 Data Extraction

6. Triggering

6-1. Master Pulse

Conventional systems have required an additional external pulse generator in order to synchronize multiple cameras and devices.

Our new “Master Pulse” allows the ORCA-Flash4.0 V3 to truly simplify the trigger timing with its built-in timing generator.

The camera has a master pulse function which can generate pulses that is independent of the exposure or readout timing of the image sensor. The camera be synchronized with the master pulse generated timing pulses when set to external trigger mode, except for Lightsheet Readout mode and Dual Lightsheet Readout. The programmable timing output can be set to use the master pulse as a reference, so it is possible to set up a synchronous system including peripheral devices without an external pulse generator.

This function can be turned ON and OFF. (Default is OFF)
The master pulse supports free running mode, start trigger mode and burst mode. The range of interval time is 10 μ s to 10 s, and the step is 1 μ s for the master pulse.

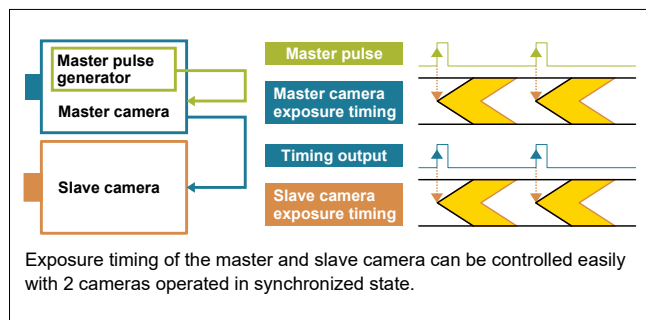

Fig. 24 Example of exposure timing control

6-2. Trigger output

In order to synchronize the camera with an external device, ORCA-Flash4.0 V3 is equipped with various trigger output signals in which the camera becomes the master and the external device the slave.

6-2-1. Global exposure timing output

The camera outputs the period where all lines are exposed simultaneously. Since the timing of the exposure in each line is different for the rolling shutter, it is possible that a phenomenon may be observed partially in each of two consecutive frames. A global exposure timing allows for synchronizing of the event to the time when all lines are exposing, therefore moving the event into a single frame. Exposure should be set to longer than readout to take advantage of this synchronization. For more information on the timing, please refer to Fig. 28 to 39. Please note that the global exposure timing output is not output in the light sheet mode.

6-2-2. Programmable timing output

For the programmable timing output, pulses with a delay time and pulse width are set by a command, and referenced to the user selection of the end of the sensor readout, Vsync (vertical synchronous signal) or Hsync (horizontal synchronous signal).

By using the programmable timing output, simple synchronization with external devices will be enabled, allowing it to replace a simple delay unit or pulse generator. The setting range of time delay is 0 μ s to 10 s and pulse width is 10 μ s to 10 s.

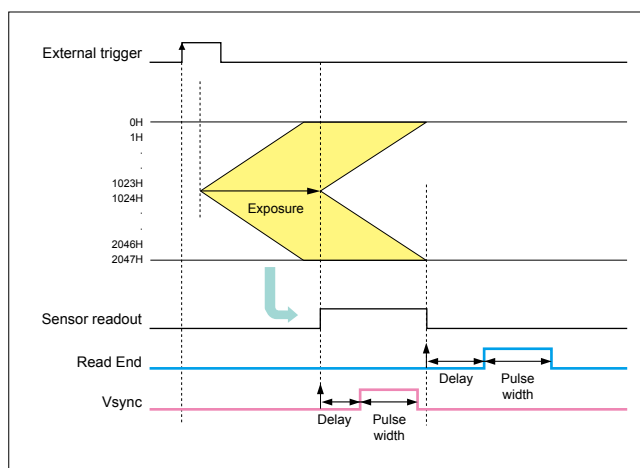

Fig. 25 Programmable timing output (normal area mode, edge trigger)

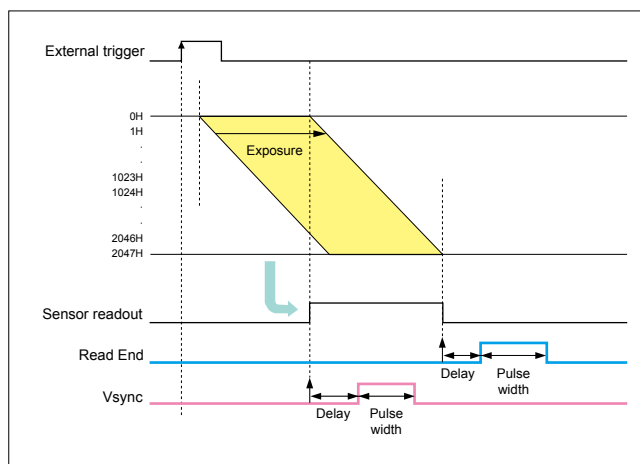

Fig. 26 Programmable timing output (light sheet mode, edge trigger)

6-2-3. Pre-Hsync

In light sheet mode a timing signal referenced to the horizontal line readout may be output by setting the Hsync output trigger. The delay and width is set by command. In addition the start of the light sheet mode may be delayed by setting a number of Pre-Hsync pulses.

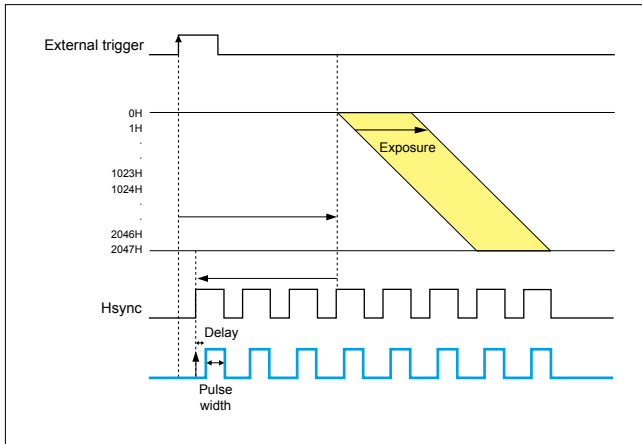

Fig. 27 Pre-Hsync output (light sheet mode, edge trigger)

6-2-4. Trigger ready output

When operating in the external trigger mode, the interval from one exposure to the next can be shortened with the use of the trigger ready output.

When the camera is operating in the external trigger mode, for example for the edge trigger, the next exposure can start only after the sensor readout has ended. For this reason, a trigger for the next start of exposure cannot be accepted during an exposure or readout. By monitoring the output a signal at the end of readout the input trigger may be sent immediately to start the next exposure, reducing the dead time as much as possible.

7. Various Timing Charts

7-1. Explanation of timing charts

In Chapter 7, each imaging mode is described with reference to a timing chart. First, the chapter discusses how to read the timing charts.

The horizontal axis in Fig. 28 represents the passage of time. The part colored in yellow represents the exposure condition of the CMOS sensor. The top of the figure represents the top of the screen of the CMOS sensor, and the bottom of the figure represents the bottom of the screen of the CMOS sensor. As the CMOS sensor controls the exposure in one horizontal line increment, the transverse timing of the CMOS sensor is omitted in the figure. This figure is when the external trigger is input.

After inputting an external trigger (1), a sensor readout (readout of the data in the previous frame) is started (2), and the center lines (1023H, 1024H) of the screen will start exposing at the same time. The camera data output also begins with the start of the sensor readout (3).

With the passage of time, the sequential readout of previous frames on a line-by-line basis and exposure of the next frame start.

In the period where all lines are exposed (red square in the figure), the global exposure output (4) is output. Also, a trigger ready output (5) will be output once the readout of one frame is completed and the next external trigger reception is enabled, and if a USB 3.0 is connected, USB 3.0 data output will be output (6).

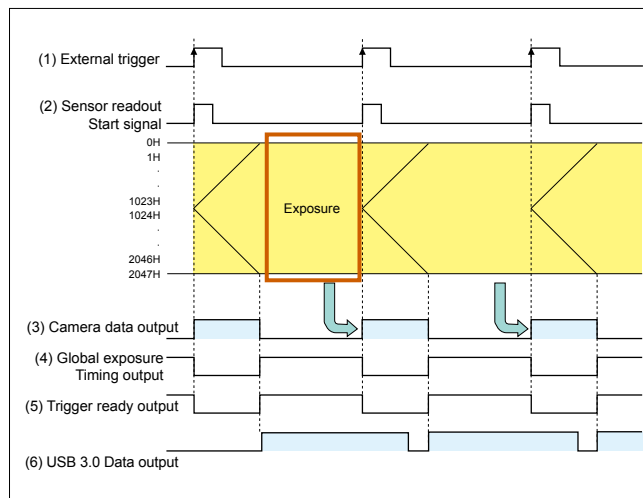

Fig. 28 Camera operation mode

7-2. Normal area mode

7-2-1. Free running mode

ORCA-Flash4.0 V3 allows the exposure time to be set by an external command and is equipped with free running mode that operates in the camera itself. The free running mode is equipped with the normal readout mode (when the exposure time is longer than the readout time of one frame) and electronic shutter mode (when the exposure time is

shorter than the readout time of one frame). These modes automatically switch according to the exposure time setting.

7-2-1-1. Normal readout mode

The normal readout mode is a mode where the set exposure time is either the same as or longer than the readout time. If the exposure time is set to be equal or longer than the readout time for one frame, the global exposure timing output signal will be output when exposure starts for the period in which the exposure is performed in all pixels. When the exposure ends and readout of the sensor starts, the camera data is output at the same time as the sensor readout start signal is output.

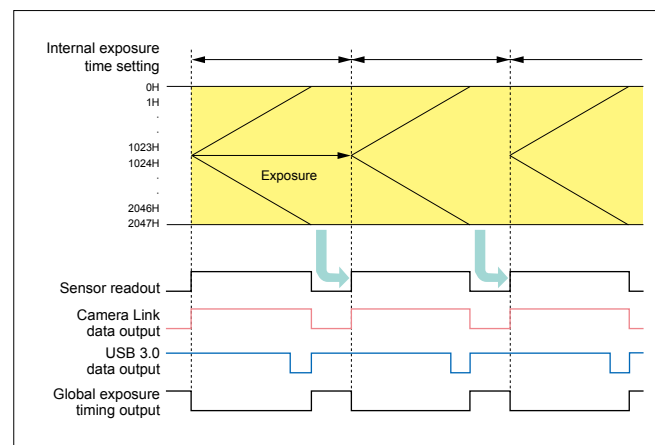

Fig. 29 Normal readout mode

7-2-1-2. Electronic shutter mode

The electronic shutter mode is used for imaging with a suitable signal level when the light intensity is too high and output signal overflows in the normal readout mode. Although the exposure time is shorter than one frame, the frame rate is 100 frames/s (when reading out all pixels). Although the basic timing is the same as the normal readout mode, because the exposure time is short, the global exposure timing output will not be output.

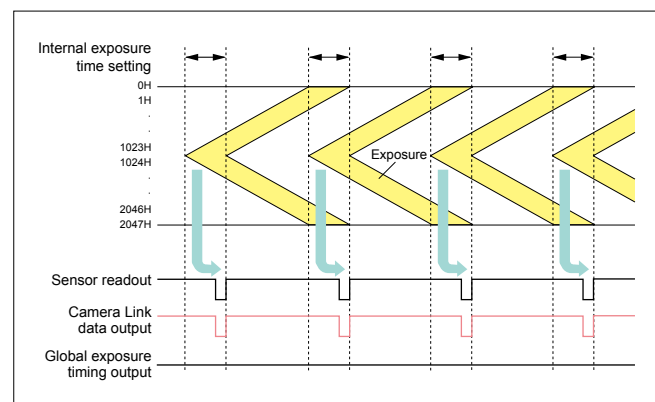

Fig. 30 Electronic shutter mode

7. Various Timing Charts

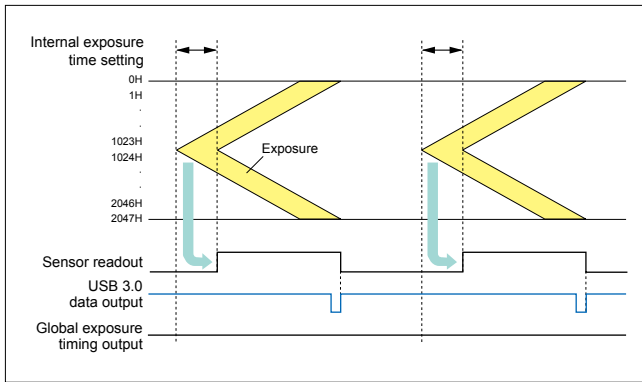

Fig. 31 Electronic shutter mode (USB 3.0)

7-2-2. External trigger mode

As an external device becomes the master when performing image capturing in synchronism with the external device, ORCA-Flash4.0 V3 is equipped with various external trigger modes in which the camera becomes the slave.

7-2-2-1. Edge trigger mode

The edge trigger mode is used when performing exposure in synchronization with an external trigger signal. The exposure time is externally set by a command. In the edge trigger mode, the exposure of the center lines (1023H and 1024H in the figure below) is started by the edge (rising/falling edge) timing of the trigger signal input to the camera. Then, after the readout time of one line, exposure of the next lines (1022H, 1025H) starts, after which each line successively starts the exposure. Fig. 32 shows the timing chart of the rising edge example.

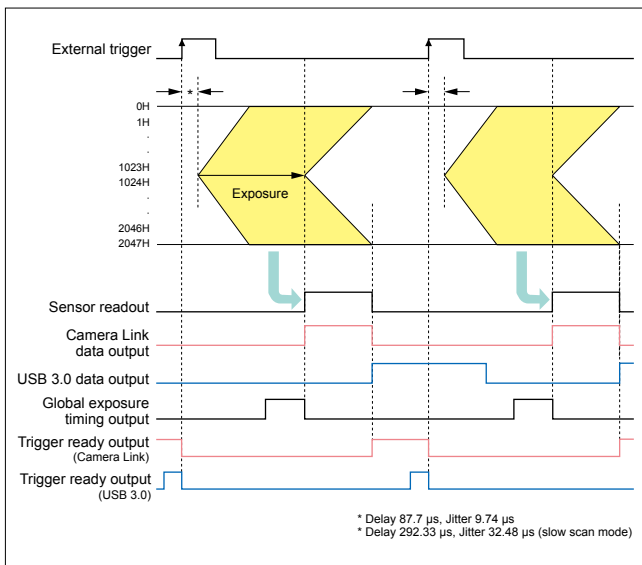

Fig. 32 Edge trigger mode

7-2-2-2. Global reset edge trigger mode

In the edge trigger mode, the global reset is made by the edge (rising/falling edge) of the trigger signal input to the camera. At the same time, global exposure is started, and

the readout is done by normal readout. The timing other than the reset is the same as the edge trigger mode.

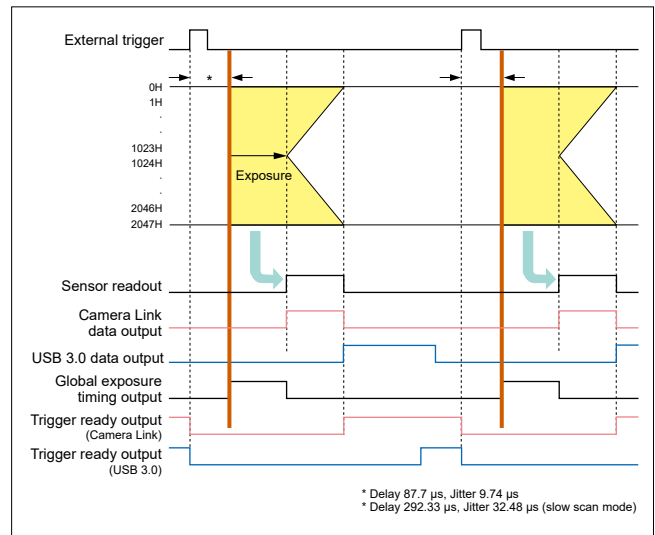

Fig. 33 Global reset edge trigger mode

7-2-2-3. Level trigger mode

The level trigger mode is used when performing exposure in synchronization with an external trigger signal and externally controlling the exposure time with a trigger signal. The level trigger mode is a mode where the exposure starts when the input trigger signal switches from Low to High (or High to Low), and continues until the end of the period of High (or Low). An example of the "High" trigger level is shown below. When the trigger signal goes to High, the exposure of the central lines (1023H, 1024H) starts, then after the readout time of one line, exposure of the next line starts, after which each line successively starts exposure. The exposure of the first line stops at the moment the signal level goes to Low to start the readout of the signal. The exposure time of each line is the time from when the trigger level goes to High until it goes to Low.

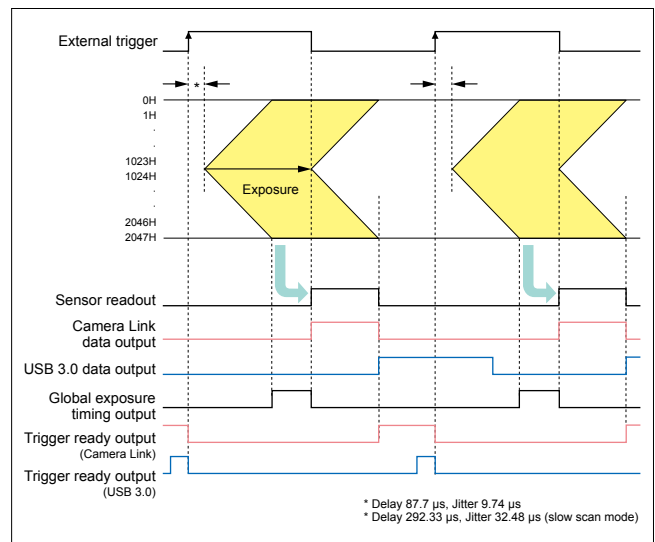

Fig. 34 Level trigger mode

7-2-2-4. Global reset level trigger mode

In the global reset, the level trigger mode is a mode where the global reset is performed and exposure is started when the input trigger signal switches from Low to High (or High to Low), and the exposure continues until the end of the period of High (or Low). As with the edge trigger mode, the readout is done by normal readout. The timing other than the reset is the same as the level trigger mode.

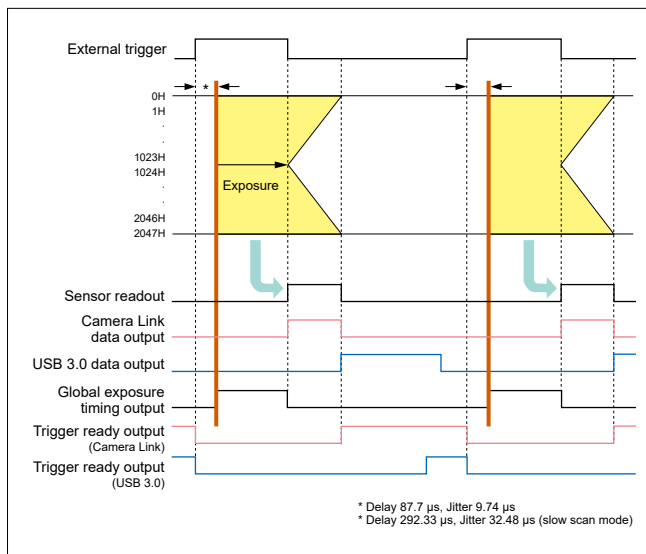

Fig. 35 Global reset level trigger mode

7-2-2-5. Synchronous readout trigger mode

In the synchronous readout trigger mode, the exposure of the camera is ended and readout is started, and the next exposure is simultaneously started by the edge (rising/falling edge) of the trigger signal input to the camera. That is, the exposure time will be the interval between the edges of an external trigger.

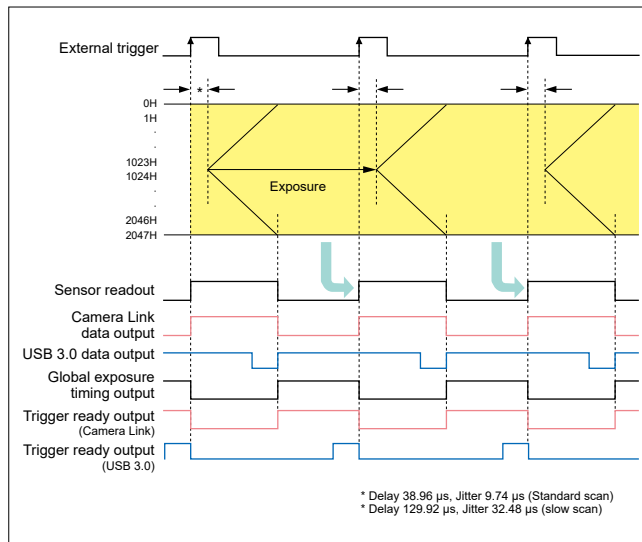

Fig. 36 Synchronous readout trigger mode (rising edge)

Also, the synchronous readout trigger mode is capable of pulse count readout where the readout is performed once per any number of input triggers. The figure below is an example where one readout is made with respect to three input triggers.

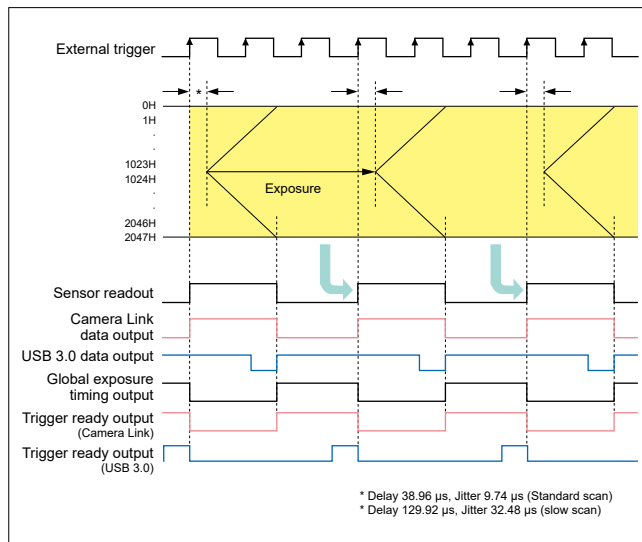

Fig. 37 Synchronous readout trigger mode (pulse count)

7-2-2-6. Start trigger mode

The start trigger mode is a mode that captures continuous images with one external trigger pulse, and as it operates in free running, it is capable of operating at the fastest frame rate.

In the start trigger mode, the exposure of the camera is started at the same time as the camera is switched to the free running by the edge (rising/falling edge) of the trigger signal input to the camera.

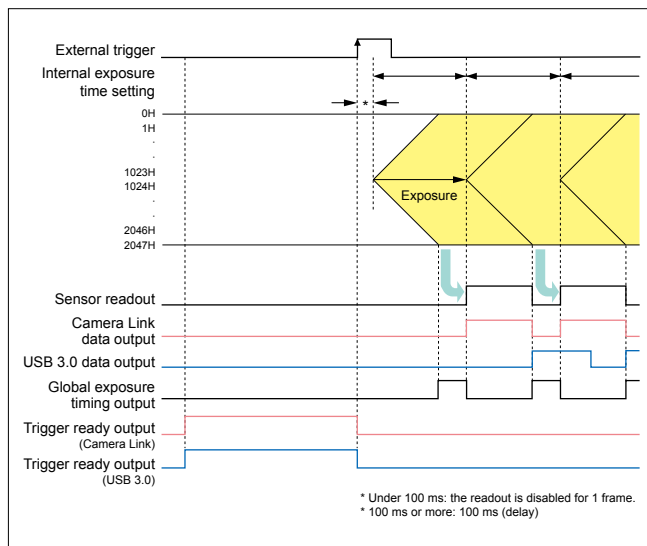

Fig. 38 Start trigger mode (rising edge)

7-2-2-7. Slow scan mode

In the slow scan mode, the readout slope is changed from 10 ms to 30 ms, and the fastest frame rate is 30 frames/s. As there is no change in the relationship of each trigger input and output other than the readout slope, please see the timing diagrams of Fig. 28 to 38 for the standard scan.

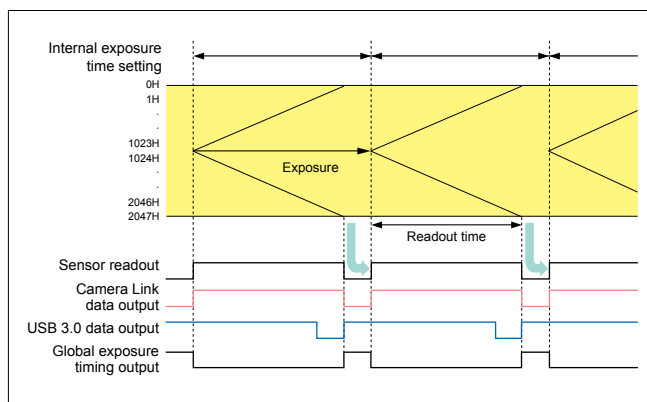

Fig. 39 Slow scan mode, free running mode

7-3. Light sheet mode

7-3-1. Free running mode

As with the normal area mode, it allows the exposure time to be set by an external command and is equipped with free running mode that operates within the camera itself. In the free running mode, the exposure time and readout direction can be set by an external command. In the top to bottom readout, exposure is performed from line 0H of the sensor top to 2047H in 1H increments. When the exposure ends, readout continues sequentially from line 0H.

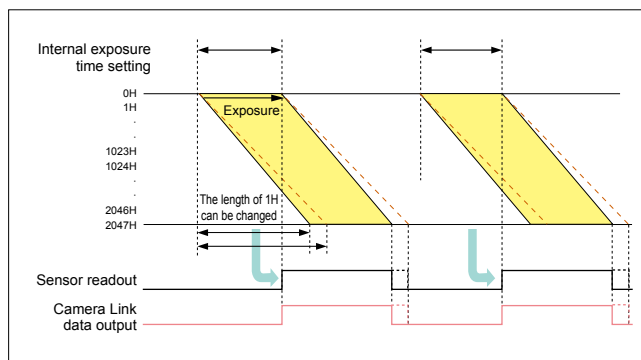

Fig. 40 Free running mode (top to bottom readout)

7-3-2. Edge trigger mode

In the edge trigger mode, exposure is made sequentially from 0H by the edge (rising/falling edge) of the trigger signal input to the camera. When the exposure ends, readout is performed by each horizontal line.

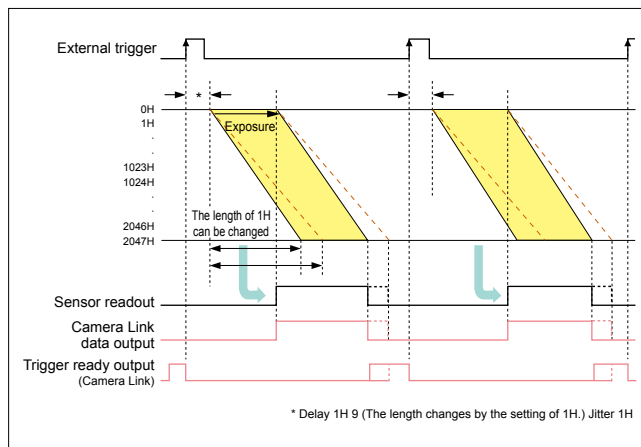

Fig. 41 Edge trigger mode (top to bottom readout)

7-3-3. Start trigger mode

The start trigger mode is used when controlling the timing for externally starting the image capture as with the normal area mode. In the start trigger mode, the exposure of the camera is started at the same time as the camera is switched to the free running by the edge (rising/falling edge) of the trigger signal input to the camera.

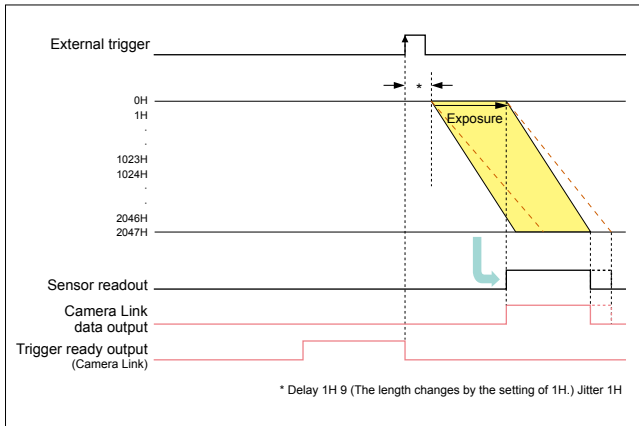

Fig. 42 Start trigger mode (top to bottom readout)

8. Software Support

8-1. DCAM-API

ORCA-Flash4.0 V3 is supported by DCAM-API, which is provided as driver software. DCAM-API supports many of our digital cameras for scientific measurement as well as ORCA-Flash4.0 V3, and is designed to absorb the difference in their properties and to allow control by a common calling method.

For detailed information such as compatible OS, I/F card and application software, please contact the sales representative. Note that just as the 64 bit version is recommended for the OS, the 64 bit compatible version is recommended for the application software.

8-2. DCAM-SDK & DCIMG-SDK

The SDK is a Software Development Kit for the integration of Hamamatsu cameras with the customer software. You may develop own application software depends on the needs, for camera control with the DCAM-SDK and for recording DCIMG files with the DCIMG-SDK.

You are available to download our DCAM-SDK and DCIMG-SDK from the link below with the user registration completed and please refer to Hamamatsu software information as well from the same page.

<https://dcam-api.com/>

8-3. GPUs

Sample code for GPU

Various kinds of sample codes for application software Development are included in the DCAM-SDK, one of which is the use for incorporating GPU processing power into your image acquisition workflow. Through the combination of DCAM-API and CUDA, offering simple with powerful and native function groups, Hamamatsu is open for the free software development by the SDK users.

8-4. Third party software support/options

As imaging setups become more complex, software has to not only to control a camera, but many other devices such as microscopes, stages and filter wheels... Therefore, software companies have integrated Hamamatsu DCAM based cameras into their software products.

Third party software is listed on here.

http://camera.hamamatsu.com/jp/en/software/third_party_software/index.html

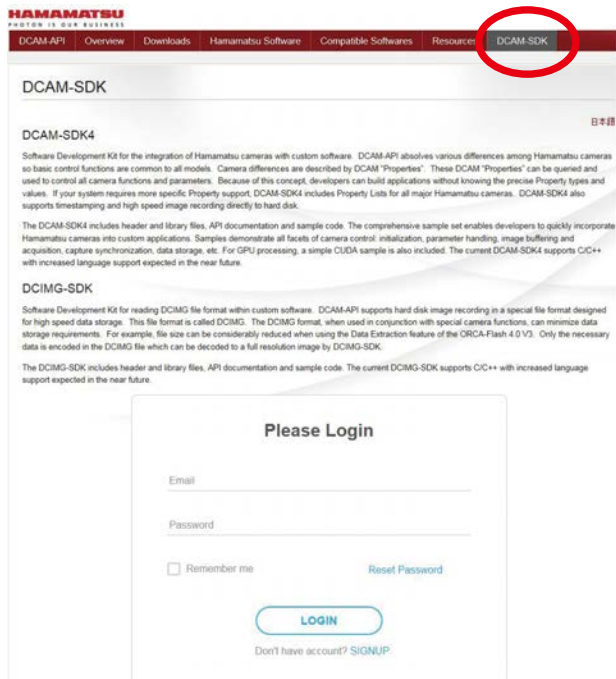

9. Understanding SNR

9-1. SNR and rSNR chart

How can I easily compare cameras?

No single technical specification can provide all the necessary information to match a camera to an application. But when the quantum efficiency and noise characteristics of a camera are considered in light of the signal and signal noise, we can understand the theoretical limits of a camera under the full range of light conditions. These signal to noise (SNR) curves provide tremendous value in predicting which camera performs best for certain applications, assuming the light levels for that application are known (more on this later). To make SNR data even more approachable, a useful variation is to look at relative SNR (rSNR), where all data is normalized to an imaginary "perfect" camera that has 100 % QE and zero noise. With this transformation, it's easy to see that at the lowest light levels (less than 4 photons per pixel with 0 background), EM-CCDs achieve the highest possible SNR. And yet, above 4 photons per pixel, ORCA-Flash4.0 V3 surpasses the SNR performance of the EM-CCD and exceeds all other technology, including CCD and previous generations of sCMOS. This SNR performance, combined with fast frame rates and large field of view make the ORCA-Flash4.0 V3 an excellent choice for most every biological application.

Calculating SNR

Calculating SNR is a simple ratio of the total signal to the total noise.

For microscope cameras, the equation looks like this:

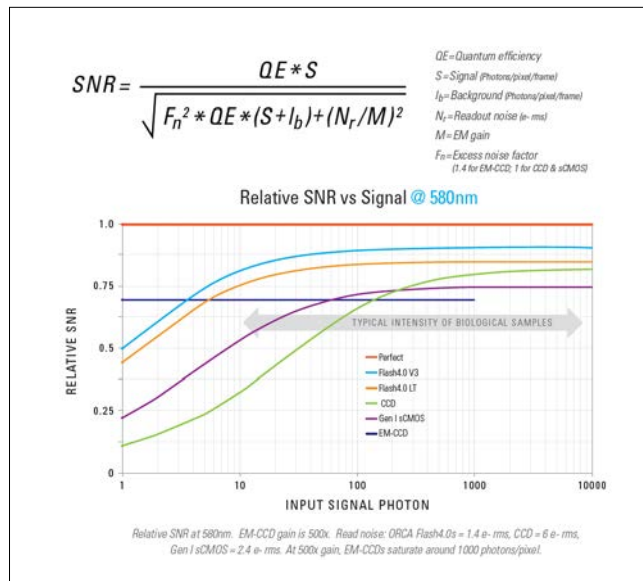

10. Application Examples

10-1. Super Resolution Microscopy

Widefield fluorescence microscopy has been and remains an essential tool for understanding complex biological processes. And, as the questions biologists are asking have moved more and more towards the molecular level, overcoming the diffraction limit of light microscopy (about 200 nm) has become increasingly important. Over the past several years advances in localization or “super resolution” microscopy have been opening doors to visualizing and measuring cellular structures with unprecedented detail. For lack of a better choice EMCCDs have been widely used as the detector in most localization microscopy systems. But now there is a better choice. Hamamatsu’s ORCA-Flash4.0 series of sCMOS cameras have demonstrably improved the precision of super resolution imaging. Our latest in the series, the ORCA-Flash4.0 V3, is ideally suited for this challenging application. The increased signal to noise ratios and ideal pixel size of this camera offer more precise data resulting in an increase in localization precision.

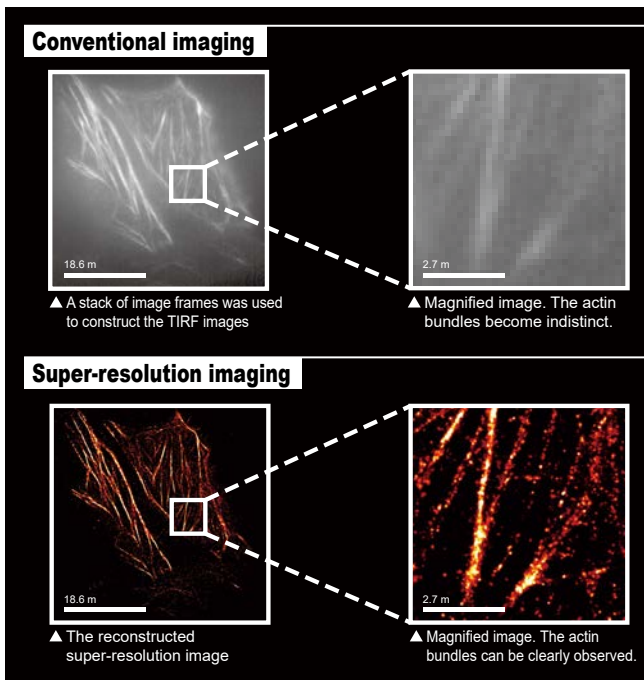

10-2. Lightsheet Microscopy

“Lightsheet Readout Mode” is a unique and patented feature of Hamamatsu sCMOS cameras which can improve signal to noise ratios in Lightsheet microscopy. Utilizing selective plane illumination, Lightsheet microscopy is a fluorescence method that places a thin sheet of excitation light across only the focal plane being imaged. The sheet of light is swept in very precise synchronization to the rolling shutter of the camera. The scan height of the rolling shutter effectively becomes a slit, enabling less background signal and scattered light. By using this combination of illumination and camera readout, very fast acquisition of optically sectioned images is enabled. Additionally, there is significantly reduced photobleaching and phototoxicity to the sample as compared to many other methods. Lightsheet microscopy is used for live cell imaging at scales that range from small groups of cells to whole organisms. The rapid increase in the use of this technique over the past several years has been remarkable.

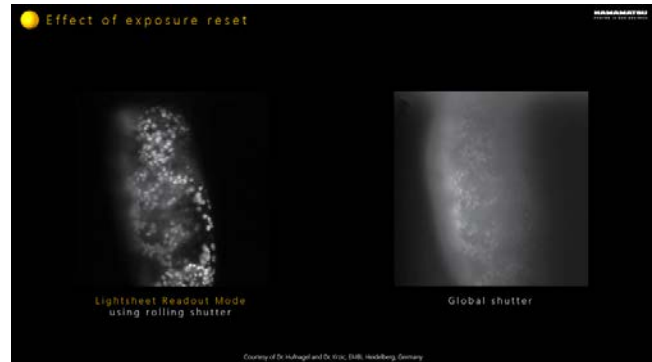

11. Diagrams

11-1. Dimensional Outlines

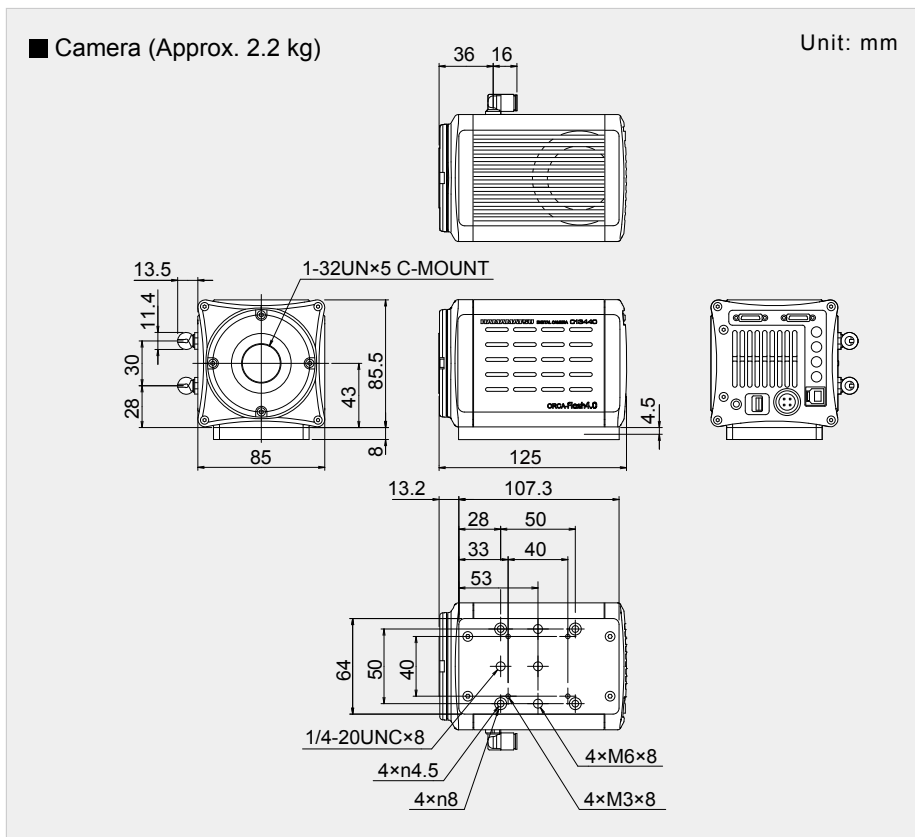

11-2. System Configuration

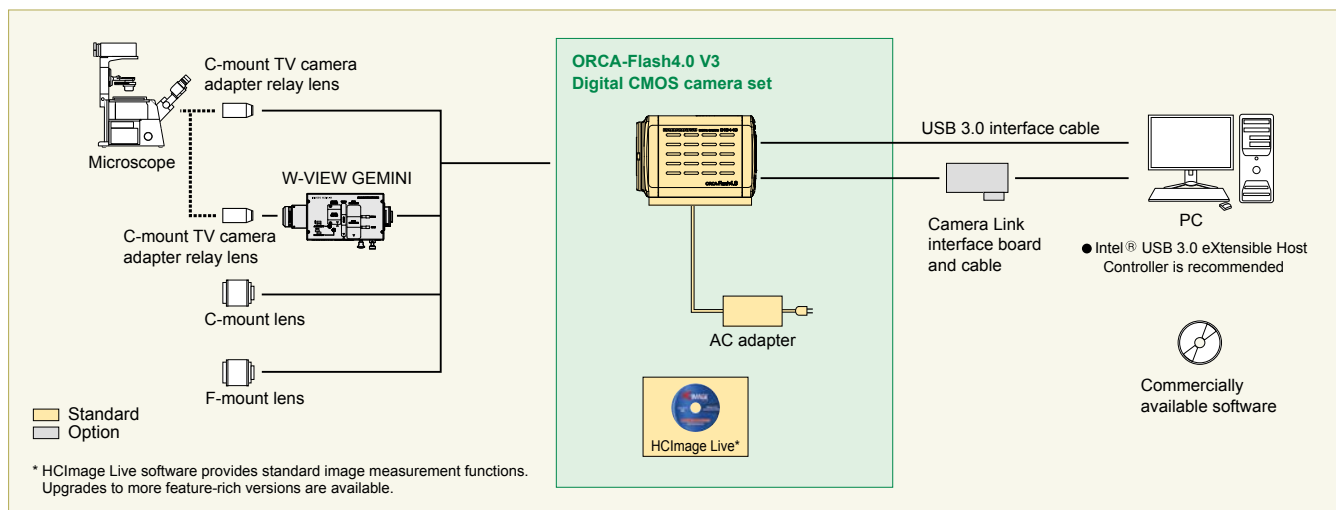

11-3. Options

Model Name	Product Name
A10788-04	Hose set w/no seams
A12106-05	SMA-BNC external trigger cable, 5 m
A12107-05	SMA-SMA external trigger cable, 5 m
A11185-01	Adjuster pole for C13440-20CU
A13261-02	Mounting bracket (C13440-20CU); for cables
A12801-01	W-VIEW GEMINI Image Splitting Optics
A12801-10	W-VIEW GEMINI-2C Image Splitting Optics

11-3-1. W-VIEW GEMINI



The W-VIEW GEMINI is an image splitting optics which provides one pair of dual wavelength images separated by a dichroic mirror onto a single camera. Simultaneous image acquisition of dual wavelength images allows you high speed ratio metric imaging and other multiple fluorescence applications.

The W-VIEW GEMINI is designed to take advantage of the wide field of view provided by sCMOS cameras. Up to 13 mm×6.4 mm F.O.V. and resolution of up to approximately 2000 pixels×1000 pixels for each image.

Because it is compatible with commercially available filters, the W-VIEW GEMINI allows for great wavelength flexibility. Choose the dichroic, bandpass and neutral density filters that work for your experimental question.

The W-VIEW GEMINI has a correction lens unit in the long wavelength path and it can improve the magnification difference of two wavelength images caused by chromatic aberration.

The right images show an example of the magnification difference caused by chromatic aberration is improved by the correction lens unit.

The W-VIEW GEMINI is designed to be easily adjusted when used with any camera. And, when using a Hamamatsu camera, the included “W-VIEW Adjustment” software makes the process even faster by simultaneously displaying and magnifying nine strategic points on the concentric chart (also included). This visual feedback lets the user dial in alignment quickly and accurately.

11-3-2. W-VIEW GEMINI-2C



Unrivaled Optical Quality Provides Superior Images

- 1. Custom Designed Lenses Optimized for Fluorescent Imaging**
 Using custom designed optics, our engineers fully optimized system performance, offering super resolution quality by minimizing point spread function (PSF) degradation, field curvature and wave front aberration.
- 2. Wide Field of View (20 mm for standard imaging, 12 mm for diffraction-limited imaging)**
 Maintaining optical quality at the edges of the field demands extra care. The W-VIEW GEMINI-2C delivers excellent performance over the entire field of two ORCA-Flash4.0 sCMOS cameras and diffraction-limited performance within the center 12 mm diameter FOV.
- 3. Ultra-Low Distortion (0.05 %), High Spatial Uniformity (98 %), High Transmission (98 % @ 450 nm to 800 nm)**
 This unmatched level of optical performance delivers bright, even, chromatic aberration-corrected images to both cameras.

MEMO

Product and software package names noted in this documentation are trademarks or registered trademarks of their respective manufacturers.

- Subject to local technical requirements and regulations, availability of products included in this promotional material may vary. Please consult your local sales representative.
- Information furnished by HAMAMATSU is believed to be reliable. However, no responsibility is assumed for possible inaccuracies or omissions.

Specifications and external appearance are subject to change without notice.

- Graphs and other material given are representative examples and not guarantees.
- The content of this catalog is current as of January 2018. The content of this catalog may change without notice for improvements.

© 2018 Hamamatsu Photonics K.K.

HAMAMATSU PHOTONICS K.K. www.hamamatsu.com

HAMAMATSU PHOTONICS K.K., Systems Division

812 Joko-cho, Higashi-ku, Hamamatsu City, 431-3196, Japan, Telephone: (81)53-431-0124, Fax: (81)53-433-8031, E-mail: export@sys.hpk.co.jp

U.S.A.: Hamamatsu Corporation: 360 Foothill Road, Bridgewater, NJ 08807, U.S.A., Telephone: (1)908-231-0960, Fax: (1)908-231-1218 E-mail: usa@hamamatsu.com

Germany: Hamamatsu Photonics Deutschland GmbH.: Arzbergerstr. 10, D-82211 Herrsching am Ammersee, Germany, Telephone: (49)8152-375-0, Fax: (49)8152-265-8 E-mail: info@hamamatsu.de

France: Hamamatsu Photonics France S.A.R.L.: 19, Rue du Saule Trapu, Parc du Moulin de Massy, 91882 Massy Cedex, France, Telephone: (33)1 69 53 71 00, Fax: (33)1 69 53 71 10 E-mail: infos@hamamatsu.fr

United Kingdom: Hamamatsu Photonics UK Limited: 2 Howard Court, 10 Tewin Road, Welwyn Garden City, Hertfordshire AL7 1BW, UK, Telephone: (44)1707-294888, Fax: (44)1707-325777 E-mail: info@hamamatsu.co.uk

North Europe: Hamamatsu Photonics Norden AB: Torshamnsgatan 35 16440 Kista, Sweden, Telephone: (46)8-509 031 00, Fax: (46)8-509 031 01 E-mail: info@hamamatsu.se

Italy: Hamamatsu Photonics Italia S.r.l.: Strada della Moia, 1 int. 6, 20020 Arese (Milano), Italy, Telephone: (39)02-93 58 17 33, Fax: (39)02-93 58 17 41 E-mail: info@hamamatsu.it

China: Hamamatsu Photonics (China) Co., Ltd.: 1201 Tower B, Jiaming Center, 27 Dongsanhuan Beilu, Chaoyang District, 100020 Beijing, China, Telephone: (86)10-6586-6006, Fax: (86)10-6586-2866 E-mail: hpc@hamamatsu.com.cn

Taiwan: Hamamatsu Photonics Taiwan Co., Ltd.: 8F-3, No.158, Section2, Gongdao 5th Road, East District, Hsinchu, 300, Taiwan R.O.C. Telephone: (886)03-659-0080, Fax: (886)03-659-0081 E-mail: info@hamamatsu.com.tw