

NEW

# Universal streak camera

C16910 series

Temporal resolution

Less than

800 fs

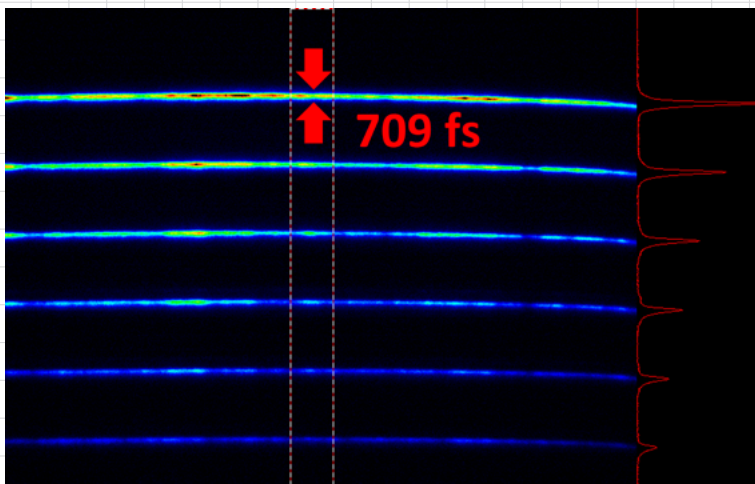

A measured pulse train of a femtosecond Ti-Sapphire laser (800 nm, pulse width about 100 fs)

Modular design  
enables a wide range of  
applications!

**HAMAMATSU**  
PHOTON IS OUR BUSINESS

# Achieves a temporal resolution of less than 800 fs for both single sweep and synchroscan sweep

The streak camera is an ultrahigh-speed detector which captures light emission phenomena occurring in extremely short time periods. The C16910 is a general-purpose model capable of measuring a variety of phenomena, from single-shot to high repetition, by combining a sweep unit and a function expansion unit.

## Features

- Less than 800 fs temporal resolution
- UV to near-infrared wavelengths
- Simultaneous measurement of light intensity on temporal and spatial (wavelength) axis
- Detects a single photon
- Improved S/N with the internal MCP
- Achieves an extinction ratio of  $10^8$  or more by using the MCP gate and the photocathode gate together

## Applications

- Fluorescence lifetime measurement, transient absorption measurement, time-resolved Raman spectroscopy
- Optical communications, response measurement of quantum devices
- Measurement of electron bunch for synchrotron and LINAC applications
- Research involving free electron lasers, and various other types of pulsed lasers
- Plasma light emission, radiation, laser ablation, combustion and explosions
- Lidar Thomson scattering, laser distance measurement
- Perovskite solar cell material development

## Operating principle

The light pulse to be measured is projected onto the slit and is focused by the lens into an optical image on the photocathode of the streak tube. Changing the temporal and spatial offset slightly each time, four light pulses, each with a different light intensity, are introduced through the slit and conducted to the photocathode. Here, the photons are converted into a number of electrons proportional to the intensity of the incident light. The four light pulses are converted sequentially to electrons which are then accelerated and conducted towards the phosphor screen. As the group of electrons created from the four light pulses passes between a pair of sweep electrodes, a high voltage is applied, resulting in a high-speed sweep (the electrons are swept in the direction from top to bottom). The electrons are deflected at different times, and at slightly different angles in the perpendicular direction, and are then conducted to the MCP (micro-channel plate). As the electrons pass the MCP, they are multiplied several thousands of times and are then bombarded against the phosphor screen, where they are converted back into light. The fluorescence image corresponding to the first incident light pulse is positioned at the top of the phosphor screen, followed by the others, with images proceeding in descending order; in other words, the axis in the perpendicular direction on the phosphor screen serves as the temporal axis. The brightnesses of the various fluorescence images are proportional to the intensities of the corresponding incident light pulses. The positions in the horizontal direction on the phosphor screen correspond to the positions of the incident light in the horizontal direction.

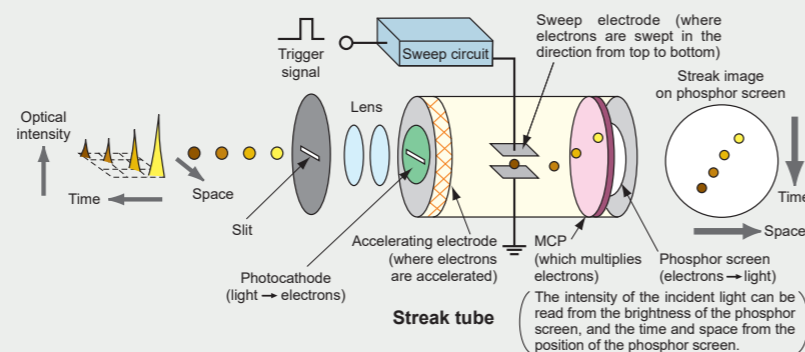

## System configuration

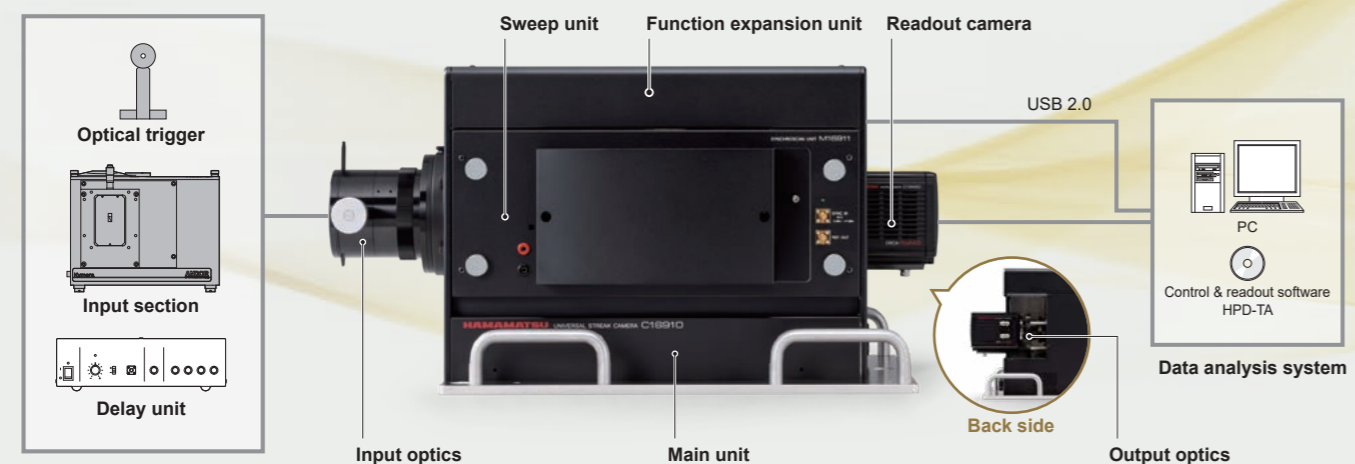

## Specifications

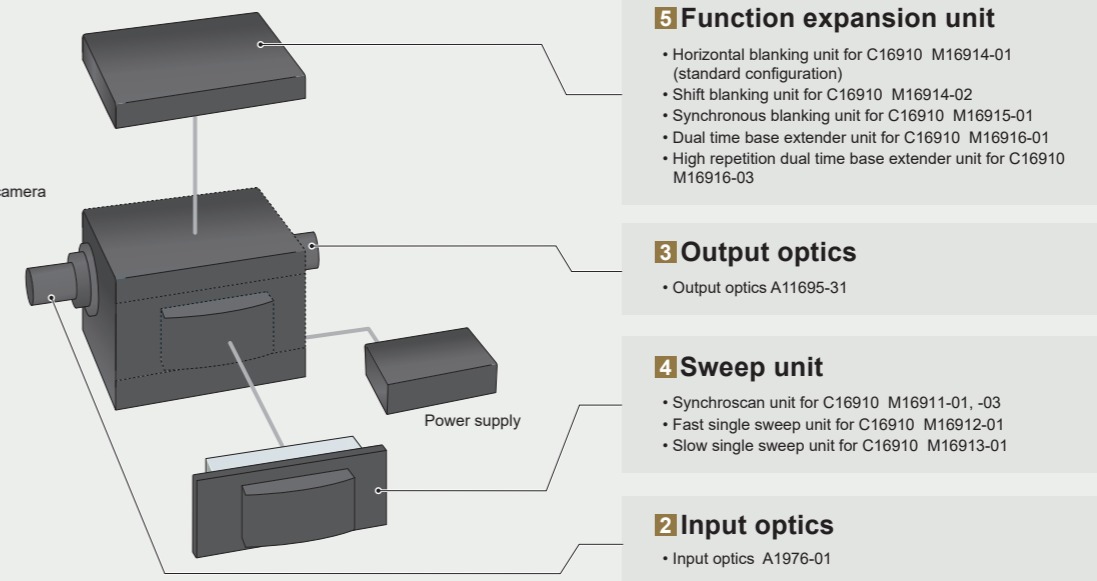

## 1 Main unit

Product number	C16910-01	C16910-02	C16910-03	C16910-04	C16910-05
Photocathode	S-20	S-1	S-20MgF2	S-25	S-20ER
Spectral response	200 nm to 850 nm	300 nm to 1600 nm	115 nm to 850 nm	280 nm to 920 nm	200 nm to 900 nm
Effective photocathode size *1	0.15 mm × 4.5 mm ± 5 % (with ORCA®-Flash4.0 V3)				
MCP gain	≥ 3 × 10 <sup>3</sup>				
Phosphor screen	P-43, φ18 mm				
Spatial resolution	≥ 35 lp/mm (center of photocathode, wavelength 530 nm)				
Interface	USB 2.0				
Power supply	AC 100 V to AC 240 V, 50 Hz/60 Hz				
Power consumption	Approx. 250 VA				

\*1 The two systems whose photocathodes are S-20 and S-20ER are also compatible with an effective photocathode with a size of 0.5 mm × 4.5 mm. Product number C16910-21 is for S-20, and C16910-25 is for S-20ER. Please contact us for more information.

## <Gate function>

Gating method	MCP + horizontal blanking	MCP + horizontal blanking + photocathode
Extinction ratio	≥ 1:10 <sup>6</sup>	≥ 1:10 <sup>8</sup>
Gate time	50 ns to continuous	
Gate trigger input	TTL 50 Ω	
Gate trigger delay time	≤ 300 ns	
Horizontal blanking repetition frequency (Max.)	4 MHz	
MCP gate repetition frequency (Max.)	10 kHz	
Photocathode gate repetition frequency (Max.)	10 kHz	

## Cooling option for C16910-02 M16917

\*Only for C16910-02

Reducing dark current noise in a photocathode by cooling it. This cooling option enables to detect low-light, which is difficult to be identified without cooling.

Cooling method	Peltier cooling
Heat dissipation method	Water cooled
Photocathode cooling temperature	Approx. 0 °C

## 2 Input optics

### Input optics A1976-01

Spectral transmission	200 nm to 1600 nm
Effective F value	5.0
Slit width	0 mm to 5 mm
Slit width reading precision	5 μm
Overall length (excluding the fitting part)	98.2 mm
Optical magnification	1:1

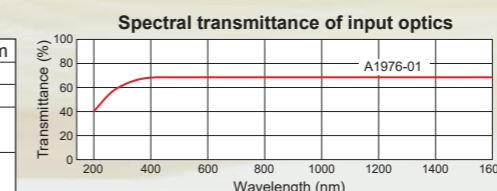

## Spectral response of the streak tube (typ.)

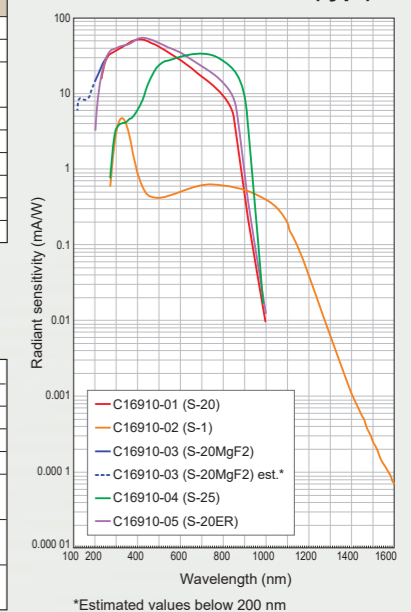

\*Estimated values below 200 nm

## 3 Output optics

### Output optics A11695-31

Image multiplication ratio	3:2
Effective F value	2.0
Lens mount	C-mount
Corresponding camera	ORCA®-Flash4.0 V3 Digital CMOS camera C13440-20CU



## Specifications

### 4 Sweep units

#### Synchroscan unit for C16910 M16911-01, -03

Sweep unit for high-sensitivity and high temporal resolution measurements when synchronized with a high-repetition laser such as a mode-locked Ti-sapphire laser.



Product number	M16911-01	M16911-03
Temporal resolution	Please refer to the table below.	
Sweep time *1	Approx. 60 ps to 1/6 fs (with ORCA®-Flash4.0 V3)	Approx. 200 ps to 1/6 fs (with ORCA®-Flash4.0 V3)
Sweep range	5 selectable ranges	
Synchroscan frequency	Factory set within 74 MHz to 165 MHz	Factory set within 38 MHz to 74 MHz
Synchronous frequency range	fs ±0.1 MHz (Range 1, Fastest range) fs ±0.2 MHz (After range 2)	fs ±0.05 MHz
Trigger jitter	Better than temporal resolution	
Trigger signal input	-3 dBm to +17 dBm, 50 Ω	
Trigger delay tuneup	≥ 360 degree	

\*1 For example, when fs is 80 MHz, the sweep time is set from the fastest range of 60 ps to 80 ps, and then 200 ps, 600 ps, 1200 ps, and 2083 ps thereafter. The fastest range is factory set from 60 ps to 80 ps depending on the time resolution.

#### Fast single sweep unit for C16910 M16912-01

High-speed sweep plug-in unit designed for high resolution single-shot measurements, but can also trigger up to 10 kHz at lower resolutions.



Temporal resolution	Please refer to the table below.
Sweep time	60 ps to 20 ns / full (with ORCA®-Flash4.0 V3)
Trigger jitter	≤ 5 ps rms
Trigger delay	Approx. 10 ns (fastest sweep range)
Maximum sweep frequency	10 kHz
Trigger signal input	± 5 V, 50 Ω
Monitor out signal	LVCOS 10 kΩ

#### Slow single sweep unit for C16910 M16913-01

A sweep unit for randomly triggered or single-shot measurements of slower phenomena.



Temporal resolution	Please refer to the table below.
Sweep time	1.2 ns to 1 ms / full (with ORCA®-Flash4.0 V3)
Trigger jitter	Better than temporal resolution
Trigger delay	Approx. 40 ns (fastest sweep range)
Maximum sweep frequency	4 MHz (fastest sweep range)
Trigger signal input	± 5 V, 50 Ω
Monitor out signal	LVCOS 10 kΩ

### <A typical example of temporal resolution (FWHM)>

The values were measured at the wavelength of 800 nm and at the center of a photoelectric surface. These do not include jitter of a light source.

Main unit	C16910-01	C16910-02	C16910-03	C16910-04	C16910-05
Sweep unit	S-20	S-1	S-20MgF2	S-25	S-20ER
M16911-01	< 800 fs	< 1.5 ps	< 800 fs	< 4 ps	< 800 fs
M16911-03		< 2 ps		< 4 ps	< 2 ps
M16912-01	< 800 fs	< 1.5 ps	< 800 fs	< 4 ps	< 800 fs
M16913-01		< 20 ps			

### 5 Function expansion units

#### Horizontal blanking unit for C16910 M16914-01 (standard configuration)

The standard unit for return sweep blanking during single-sweep operation.



Maximum repetition frequency	4 MHz
------------------------------	-------

#### Shift blanking unit for C16910 M16914-02

For use in combination with synchroscan and pulse picker or regen amplifier. For applications such as fast picosecond risetime or lifetime decay of data which may include residual light extending beyond the synchroscan's return sweep, e.g. nanoseconds to milliseconds.



Maximum repetition frequency	10 kHz
Trigger signal input	± 5 V, 50 Ω
Maximum Blanking time	10 μs

#### Synchronous blanking unit for C16910 M16915-01 (With M16911-01 Synchroscan unit)

Extends the performance of synchroscan operation by synchronously blanking the return sweep. For applications such as high-repetition light in the GHz range, or for picoseconds risetime and lifetime decay measurements on data which includes residual light beyond a few nanoseconds, but less than the synchroscan's sweep period (e.g. < 10 ns).



Synchroscan frequency	Factory set within 74 MHz to 165 MHz
Horizontal shift width	3 mm or 13 mm (at phosphor screen)

#### Dual time base extender unit for C16910 M16916-01 (Can be used with all sweep units)

For simultaneous dual-sweep operation and single channel narrow V-slit input. Compatible with all sweep plug-in units, the M10916-01 extender unit provides slower time axis in a perpendicular axis, e.g. simultaneous high-speed vertical sweep and horizontal slower sweep. For applications such as bunch length measurements or phase stability in synchrotrons.



Sweep time	100 ns to 100 ms / full (with M16911-01, -03, with ORCA®-Flash4.0 V3) 1 ms to 100 ms / full (with M16912-01, with ORCA®-Flash4.0 V3) 2 μs to 100 ms / full (with M16913-11, with ORCA®-Flash4.0 V3)
Maximum sweep frequency	10 Hz
Trigger signal input	± 5 V, 50 Ω
Monitor out signal	LVCOS 10 kΩ

#### High repetition dual time base extender unit for C16910 M16916-03

High repetition version of the M16916-01. Enables higher-repetition frequency measurements for applications such as photon correlation.



Sweep time	62.5 ns, 125 ns, 250 ns, 500 ns, 750 ns / full (with ORCA®-Flash4.0 V3)
Maximum sweep frequency	1 kHz
Trigger signal input	± 5 V, 50 Ω
Monitor out signal	LVCOS 10 kΩ

## Specifications

### 6 Readout camera

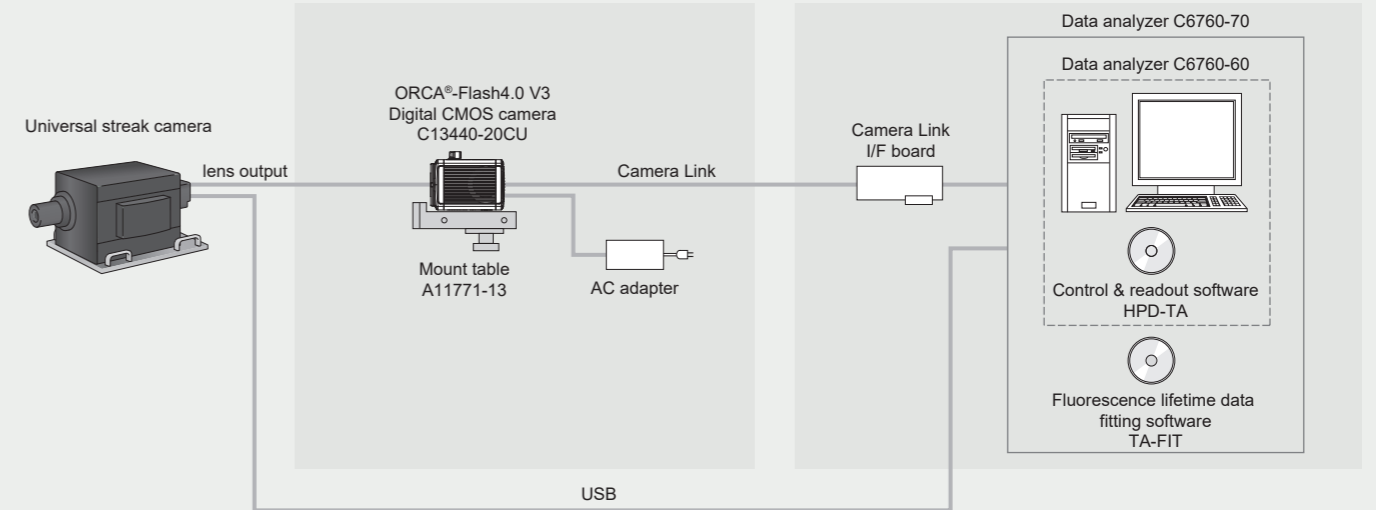

### 6 Readout camera

#### ORCA®-Flash4.0 V3 Digital CMOS camera C13440-20CU

Recommended readout camera for universal applications, including single-shot, analog, and photon counting integration.



Effective number of pixels	2048 (H) × 2048 (V)
Pixel size	6.5 μm (H) × 6.5 μm (V)
Effective area	13.312 mm (H) × 13.312 mm (V)
Number of pixels on working area	1280 (H) × 968 (V)
Working area on phosphor screen	12.48 mm (H) × 9.44 mm (V)
Exposure time	1 ms to 10 s Standard scan internal trigger mode with full resolution
Frame rate	100 frames/s, Standard scan (full resolution, Camera Link)
Digital output	16 bit
Power supply	AC 100 V to AC 240 V, 50 Hz/60 Hz
Power consumption	Approx. 120 VA

#### Mount table A11771-13

A mount table to set up and to fix a streak camera and an ORCA®-Flash4.0 V3 Digital CMOS camera.

### 7 Data analysis system

#### Data analyzer C6760-60

Supported camera	ORCA®-Flash4.0 V3 Digital CMOS camera C13440-20CU
Component	PC Liquid crystal display Cable Frame grabber board
System	Windows® 11 (64 bit)
Interface	Camera Link

#### <Control & readout software HPD-TA>

\*Including in the Data analyzer

Data acquisition	Live mode, analog integration, photon counting, sequence recording
Device control	Streak camera, readout camera, spectrograph, delay units
Profile function	Real-time display, Min./Max., FWHM, Gauss fit
Data correction	Background, sensitivity, curvature, jitter
Axis calibration	Channel, time, wavelength
File format (image)	Binary (up to 32 bit), TIFF, ASCII
File format (profile)	ASCII

#### Data analyzer C6760-70

C6760-70 is the system configuration of C6760-60 which includes the fluorescence lifetime data fitting software (TA-FIT).

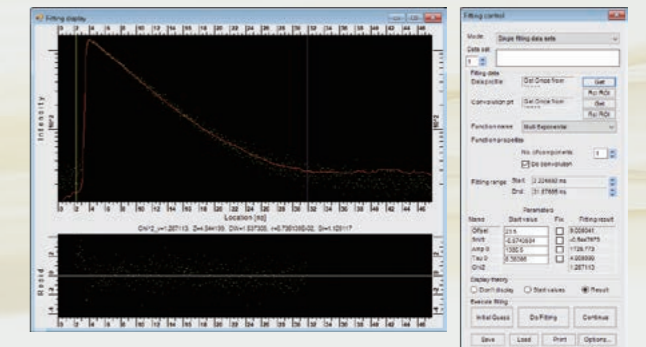

## Specifications

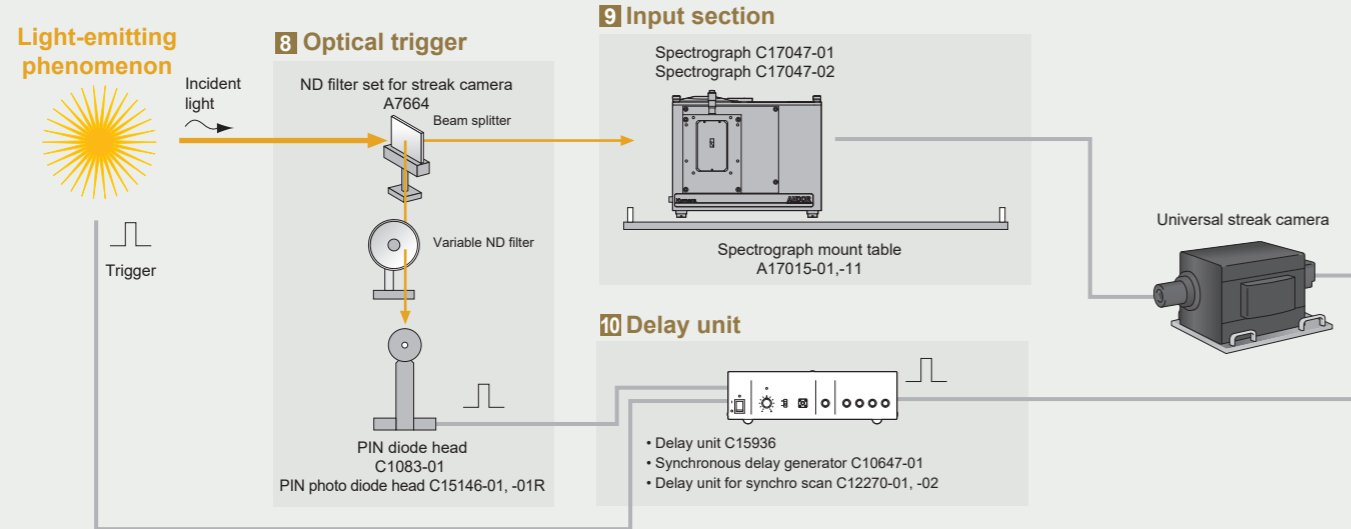

### 8 Optical trigger (PIN diode head)

#### ND filter set for streak camera A7664

The adjustment tool of input light intensity for C15146-01, -01R. A variable ND filter and a laser beam splitter are included.



#### PIN diode head C1083-01 (for low repetition)

Used to generate a trigger signal for the streak camera with lasers with low repetition rates.



Spectral response	320 nm to 1000 nm	
Risetime	0.8 ns	
Power supply	+18 V (battery)	
Dimensions / weight	Head	100 mm (W) × 156 mm (H) × 50 mm (D) Approx. 400 g
	Power supply unit	98.5 mm (W) × 35 mm (H) × 112 mm (D) Approx. 400 g

#### PIN photo diode head C15146-01, -01R (for high repetition)

Used to generate a synchronization signal for the streak camera with mode-locked lasers.



Product number	C15146-01	C15146-01R
Spectral response range	320 nm to 1000 nm	900 nm to 1700 nm
Optical input signal frequency	74 MHz to 100 MHz	
Recommended optical input level	Around 2.0 mW (averaging power)	Around 5.0 mW (averaging power)
Wavelength	800 nm	1300 nm
Repetition frequency	80 MHz	
Pulse width	≤ 1 ps	
Typical output signal level	Approx. 2.0 V (peak to peak) (typ.) (50 Ω, optical input level 2.0 mW)	Approx. 1.7 V (peak to peak) (typ.) (50 Ω, optical input level 5.0 mW)
AC input	Power supply	AC 100 V to AC 240 V
	Frequency	50 Hz/60 Hz
DC input	Input power supply	DC 24 V (This power is provided from streak camera system.)
	Power consumption	Approx. 20 VA
Dimensions	Head	88.6 mm (W) × 216 mm (H) × 88.6 mm (D)
	Controller	96.1 mm (W) × 94.1 mm (H) × 192 mm (D)
Weight	Approx. 1.8 kg	

### 9 Input section

#### Spectrograph C17047-01



#### Spectrograph C17047-02



The combination with C16910 enables to measure wavelength, time, and light intensity simultaneously.

The following are needed in order to connect these units to the streak camera:

- Spectrograph mount table
- Light source for wavelength axis calibration (mercury lamp, etc.)

	C17047-01	C17047-02
Optical layout	Czerny-Turner model	
Focal distance	193 mm	328 mm
F value	F/3.6	F/4.1
Grating	2	4
Reciprocal dispersion	3.53 nm/mm	2.19 nm/mm
Dimensions / weight	262.5 mm (W) × 233.5 mm (H) × 220 mm (D) Approx. 14.4 kg	396.6 mm (W) × 326.1 mm (H) × 229.5 mm (D) Approx. 19.8 kg

#### <Gratings (typical examples) C17047-01>

Product number	No. of grooves	Blaze wavelength	Measurement wavelength range	Resolution
A17048-005-060	50 L/mm	600 nm	Approx. 440 nm	Approx. 6.6 nm
A17048-010-078	100 L/mm	780 nm	Approx. 220 nm	Approx. 3.3 nm
A17048-015-050	150 L/mm	500 nm	Approx. 140 nm	Approx. 2.1 nm
A17048-030-050	300 L/mm	500 nm	Approx. 72 nm	Approx. 1.1 nm
A17048-060-050	600 L/mm	500 nm	Approx. 35 nm	Approx. 0.52 nm
A17048-120-050	1200 L/mm	500 nm	Approx. 16 nm	Approx. 0.24 nm
A17048-MR-UV	Mirror	UV-VIS	-	-

#### <Gratings (typical examples) C17047-02>

Product number	No. of grooves	Blaze wavelength	Measurement wavelength range	Resolution
A17049-003-025-HL	30 L/mm	250 nm Holographic	Approx. 440 nm	Approx. 6.6 nm
A17049-005-060	50 L/mm	600 nm	Approx. 260 nm	Approx. 3.9 nm
A17049-010-078	100 L/mm	780 nm	Approx. 130 nm	Approx. 2.0 nm
A17049-015-050	150 L/mm	500 nm	Approx. 88 nm	Approx. 1.3 nm
A17049-030-050	300 L/mm	500 nm	Approx. 44 nm	Approx. 0.66 nm
A17049-060-050	600 L/mm	500 nm	Approx. 21 nm	Approx. 0.32 nm
A17049-120-050	1200 L/mm	500 nm	Approx. 10 nm	Approx. 0.15 nm
A17049-MR-UV	Mirror	UV-VIS	-	-

#### Spectrograph mount table A17015-01 (Spectrograph C17047-01) A17015-11 (Spectrograph C17047-02)

#### Turret A17057-01 for C17047-01 (Andor spectrograph, Kymera-193i)

\* Up to 2 gratings can be installed

#### Turret A17057-02 for C17047-02 (Andor spectrograph, Kymera-328i)

\* Up to 4 gratings can be installed

#### FC adapter A6368

Fiber-optic input optics can be connected in place of the incident light slit in the streak camera.

## Specifications

### 10 Delay unit

#### Delay unit C15936

A jitter-free delay unit that can be used for single-sweep as well as synchroscan setups.



Variable delay range	0 ns to 31.96 ns
Delay setting range	30 ps, 60 ps, 120 ps, 250 ps, 500 ps, 1 ns, 2 ns, 4 ns, 8 ns, 16 ns
Minimum delay time	Approx. 12 ns
Maximum input signal voltage	10 V
Interface	USB 3.0
Power supply	AC 100 V to AC 240 V, 50 Hz/60 Hz
Power consumption	Approx. 30 VA
Dimensions / weight	262 mm (W) × 82 mm (H) × 333 mm (D) / Approx. 3.2 kg

### Other

Other peripheral devices such as PLP-10 Laser diode head may also be available. Please feel free to consult with your local sales representative.

### Synchronous delay generator C10647-01

When using a Ti-sapphire laser in conjunction with a pulse picker, this unit generates low-jitter trigger signals synchronized with the laser repetition rate.



Mode-lock IN	Input signal frequency	10 MHz to 200 MHz
	Input signal level	0 dBm to 15 dBm, 50 Ω
TRIG.IN	Input signal frequency	0 Hz to 16 MHz
	Input signal level	+0.25 V to +3.3 V, 50 Ω / High Z(10 kΩ)
OUTPUT A	Output signal level	2 V, 50 Ω
OUTPUT B, C, D	Output signal level	2.5 V, 50 Ω
Operation mode	INTERNAL, EXTERNAL, DUMP	
Interface	RS-232C	
Power supply	AC 100 V to AC 240 V, 50 Hz/60 Hz	
Power consumption	Approx. 50 VA	
Dimensions / weight	262 mm (W) × 81 mm (H) × 333 mm (D) Approx. 3.2 kg	

### Delay unit for synchro scan C12270-01, -02

Used in combination with a synchroscan unit M16911-01, the C12270 is used to adjust the phase of the synchronization signal. In addition, the phase can be stabilized, thereby allowing the stable acquisition of streak images over a long period of time.



Product number	C12270-01	C12270-02
Input signal	INPUT	Input signal frequency 74 MHz to 110 MHz
	REF.IN	Input signal level -3 dBm to +6 dBm, 50 Ω
		Input signal level -35 dBm to +10 dBm, 50 Ω
Output signal level *1	0 dBm to +10 dBm, 50 Ω	
Valuable delay range	Phase angle 360°	
Interface	USB 2.0	
Power supply	AC 100 V to AC 240 V, 50 Hz/60 Hz	
Power consumption	Approx. 50 VA	
Dimensions / weight	262 mm (W) × 81 mm (H) × 333 mm (D) Approx. 3.5 kg	

\*1 The output signal level changes depending on the input signal level, delay, and drift amount when locked.

## Dimensional outlines (Unit: mm)

- Universal streak camera C16910  
 + Input optics + Output optics + Synchroscan unit for C16910 (M16911-01) + Horizontal blanking unit for C16910 (M16914-01)  
 + Readout camera ORCA®-Flash4.0 V3 Digital CMOS camera (C13440-20CU)  
 (Approx. 30.5 kg)

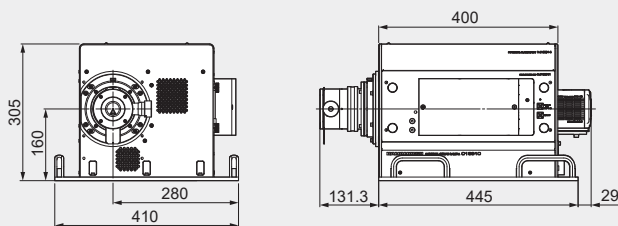

- Power supply  
 (Approx. 6.1 kg)

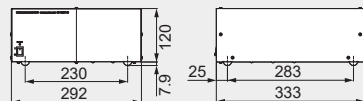

- Universal streak camera C16910  
 + Readout camera ORCA®-Flash4.0 V3 Digital CMOS camera (C13440-20CU) + Spectrograph (C17047-01) + Spectrograph mount table (A17015-01)  
 (Approx. 52.4 kg)

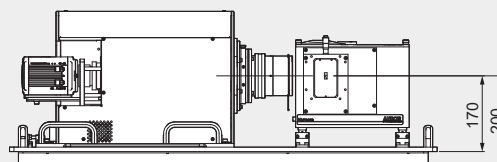
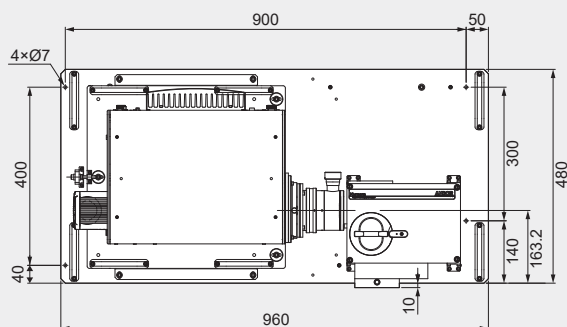

- Universal streak camera C16910  
 + Readout camera ORCA®-Flash4.0 V3 Digital CMOS camera (C13440-20CU) + Spectrograph (C17047-02) + Spectrograph mount table (A17015-11)  
 (Approx. 68.3 kg)

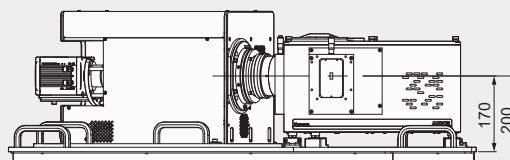
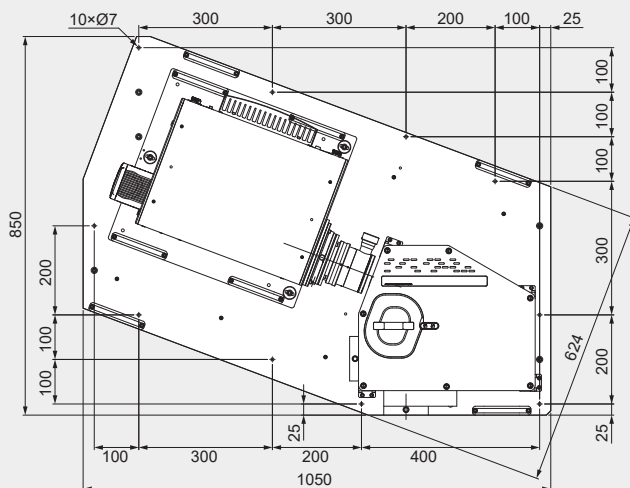

- ORCA is a registered trademark of Hamamatsu Photonics K.K. (China, EU, Japan, UK, USA).
- Windows is a registered trademark of Microsoft Corporation in the USA (and other countries).
- The product and software package names noted in this brochure are trademarks or registered trademarks of their respective manufacturers.
- Subject to local technical requirements and regulations, availability of products included in this brochure may vary. Please consult your local sales representative.
- The products described in this brochure are designed to meet the written specifications, when used strictly in accordance with all instructions.
- The spectral response specified in this brochure is typical value and not guaranteed.
- Specifications and external appearance are subject to change without notice.

© 2024 Hamamatsu Photonics K.K.

## HAMAMATSU PHOTONICS K.K. [www.hamamatsu.com](http://www.hamamatsu.com)

### Systems Division

812 Joko-cho, Chuo-ku, Hamamatsu City, 431-3196, Japan, Telephone: (81)53-431-0124, Fax: (81)53-433-8031, E-mail: [export@sys.hpk.co.jp](mailto:export@sys.hpk.co.jp)

U.S.A.: HAMAMATSU CORPORATION: 360 Foothill Road, Bridgewater, NJ 08807, U.S.A., Telephone: (1)908-231-0960, Fax: (1)908-231-1218

Germany: HAMAMATSU PHOTONICS DEUTSCHLAND GMBH: Arzbergerstr. 10, 82211 Herrsching am Ammersee, Germany, Telephone: (49)8152-375-0, Fax: (49)8152-265-8 E-mail: [info@hamamatsu.de](mailto:info@hamamatsu.de)

France: HAMAMATSU PHOTONICS FRANCE S.A.R.L.: 19 Rue du Saule Trapu, Parc du Moulin de Massy, 91882 Massy Cedex, France, Telephone: (33)1 69 53 71 00, Fax: (33)1 69 53 71 10 E-mail: [infos@hamamatsu.fr](mailto:infos@hamamatsu.fr)

United Kingdom: HAMAMATSU PHOTONICS UK LIMITED: 2 Howard Court, 10 Tewin Road, Welwyn Garden City, Hertfordshire, AL7 1BW, UK, Telephone: (44)1707-294888, Fax: (44)1707-325777 E-mail: [info@hamamatsu.co.uk](mailto:info@hamamatsu.co.uk)

North Europe: HAMAMATSU PHOTONICS NORDEN AB: Torshamnsgatan 35 16440 Kista, Sweden, Telephone: (46)8-509 031 00, Fax: (46)8-509 031 01 E-mail: [info@hamamatsu.se](mailto:info@hamamatsu.se)

Italy: HAMAMATSU PHOTONICS ITALIA S.R.L.: Strada della Moia, 1 int. 6, 20044 Arese (Milano), Italy, Telephone: (39)02-93 58 17 33, Fax: (39)02-93 58 17 41 E-mail: [info@hamamatsu.it](mailto:info@hamamatsu.it)

China: HAMAMATSU PHOTONICS (CHINA) CO., LTD.: 1201 Tower B, Jianning Center, 27 Dongsanhuan Beilu, Chaoyang District, 100020 Beijing, P.R. China, Telephone: (86)10-6586-6006, Fax: (86)10-6586-2866 E-mail: [hpc@hamamatsu.com.cn](mailto:hpc@hamamatsu.com.cn)

Taiwan: HAMAMATSU PHOTONICS TAIWAN CO., LTD.: 13F-1, No.101, Section 2, Gongdao 5th Road, East Dist., Hsinchu City, 300046, Taiwan(R.O.C.), Telephone: (886)3-659-0080, Fax: (886)3-659-0081 E-mail: [info@hamamatsu.com.tw](mailto:info@hamamatsu.com.tw)

Cat. No. SHSS0026E02  
 JAN/2024 HPK  
 Created in Japan